



imagination at work

GE Digital Camera

G Series : G5WP



User Manual

Preparations

Basic operation

Camera function controls

Playback

Using the Menus

Camera connectivity

Appendix

WARNING

Do not expose the camera battery pack or other accessories to rain or humidity to prevent fire hazard or electric shock.

For customers in the U.S.A.

Tested To Comply With FCC Standards FOR HOME OR OFFICE USE

FCC Statement

This device complies with part 15 of the FCC Rules. Operation is subject to the following two conditions:

(1) This device may not cause harmful interference, and (2) this device must accept any interference received, including interference that may cause undesired operation.

For customers in Europe



"CE" mark indicates that this product complies with the European requirements for safety, health, environment and customer protection. "CE" mark cameras are intended for sales in Europe.



This symbol [crossed-out wheeled bin WEEE Annex IV] indicates separate collection of waste electrical and electronic equipment in the EU countries. Please do not throw the equipment into the domestic refuse. Please use the return and collection systems available in your country for the disposal of this product.

Declaration of Conformity

Model Name: G5WP

Trade Name: GE

Responsible Party: General Imaging Co.

Address: 1411 W. 190th Street, Suite 550,
Gardena, CA 90248, U.S.A.

Telephone Number: +1-800-730-6597

(Outside U.S. & Canada: +1-310-755-6857)

Conforms to the following Standards:

EMC: EN 55022:1998/A1:2000/A2:2003 Class B
EN 55024:1998/A1:2001/A2:2003
EN 61000-3-2:2000/A1:2001
EN 61000-3-3:1995/A1:2001

following the provision of the EMC Directive (89/336/
EEC,2004/108/EEC)

SAFETY PRECAUTIONS

Camera notes:

- !** Do not store or use the camera in the following types of locations:
 - In a place where the camera can be exposed directly to the sunlight or subject to high temperature, e.g. Inside a closed car in summer.
 - In a place where the camera is subject to a high magnetic field, e.g. near motors, transformers or magnets.
- !** If the camera will not be used for a long period of time, we suggest you remove the battery and the memory card.
- !** If you carry the camera suddenly from a cold location to a warm place, moisture may condense inside the camera. We suggest you wait for a while before turning on the camera.
- !** No compensation for loss of recordings. Loss of recordings cannot be compensated for if a malfunction of your camera or recording media, etc, makes the playback of recordings not possible.
- !** To maintain the camera's waterproof feature, ensure that no foreign material interfere with the proper closing of the battery door.

Battery notes:

- !** Incorrect use of the batteries may cause them to leak, become hot, ignite or burst. Always observe the precautions given below.
 - Do not expose the batteries to water, and take particular care to keep the terminals dry.
 - Do not heat the batteries or throw them into a fire.
 - Do not attempt to deform, disassemble or modify the batteries.
 - Use GE charger in the package to charge the lithium battery only (for E and J series).
- !** Keep the batteries out of reach of babies and small children.
- !** In cold locations, battery performance deteriorates and the time for which they can be used shortens markedly.

Memory card notes:

- !** When using a new memory card, or a memory card has been initialized by a PC, be sure to format the card with your digital camera before using it.
- !** To edit image data, copy the image data to the PC's hard disk and then format memory card before any firmware upgrade.
- !** Do not change or delete the directory names, or file names in the memory card from your PC, as this may make it impossible to use the card in your camera.

Precautions of Waterproof Function

Water & Dust Proof

- The camera has JIS/IEC waterproof grade 8 (IPX8) and JIS/IEC dustproof grade 6 (IPX6). (It is tested according to GE testing condition, but no guarantee to say there is no damage or failure happened at all).
- The accessories included with the camera have no waterproof function.

Precautions Before Using

1. Please make sure that the battery cover is locked tightly.
2. Waterproof rubber and its contact surface shouldn't have scratch or foreign material between them.
3. Waterproof rubber with scratch shouldn't be used in water.
4. Neither open and close the battery cover when you are close to water and sea, nor do that by wet hands.
5. Do not use the camera in a thermal spring.
6. In water camera may sink down. A wrist strap and similar objects can let the camera not sink.

Precautions When Using

1. Don't use the camera below 5 meters underwater.
2. Don't use the camera underwater more than 2 hours.
3. Don't jump into water suddenly. The battery cover may be opened after the camera is impacted.
4. Don't open the battery cover underwater.
5. When the camera is under strong vibration, pressure or impact, please go to the sales point or our company's service site for consultation.

Maintenance Precautions After Using

1. Don't open the battery cover after water falls into the camera. In this case, wipe out the camera with a clean and dry clothing without loose fiber.
2. When the battery cover is opened, there may be water drops in the internal of battery cover and on the contact surface of camera body, please make sure to dry it out.
3. After using the camera in the water (including sea water) or places with sands, mud and other foreign materials, put it into container with clean water for cleaning as earlier as you can. After cleaning, wipe out the camera with a clean and dry clothing without loose fiber, then confirm if the buttons and other function still can work normally.
4. If there are dusts, sands and other foreign materials mixed with the waterproof rubber and its contact surface, please wipe it out with a clean and dry clothing without loose fiber.
5. Don't use chemical agent during maintenance. And, silicone grease can't be coated on the waterproof rubber.
6. When it is stored, do not interfuse any sands and other foreign materials on the waterproof rubber and its contact surface.



Waterproof rubber with scratches and cracks is potential to introduce water into camera. In this case, please go to the sales point or our company's service site for repairing or requesting to replace it with a new waterproof rubber.

BEFORE YOU START

Preface

Thank you for purchasing a GE digital camera. Please read this manual carefully and keep it in a safe place for future reference.

Copyright

© Copyright 2010 General Imaging Company All rights reserved.

No part of this publication may be reproduced, transmitted, transcribed, stored in a retrieval system, or translated into any language or computer language, in any form, by any means, without the prior written permission of General Imaging Company.

Trademarks

All trademarks mentioned in this manual are used for identification purposes only and may be properties of their respective owners.

Safety information

Please read the following important information carefully before using the product.

- Do not take apart or attempt to service the camera yourself.
- Do not drop or knock the camera. Improper handling may damage the product.
- Turn off the camera before inserting or removing the battery and memory card.
- Use only the type of battery and charger that came with the camera. Using other types of batteries or chargers may damage the camera may pose a potential safety risk, and invalidate the warranty.
- When using Li-ion batteries in this product, ensure that they are inserted correctly. Inserting the batteries upside down can cause damage to the camera and possibly pose a potential safety risk.
- Do not touch the camera lens.
- Do not expose the camera to harsh environments (i.e. high temperature and strong magnetic fields) as it may dramatically shorten the lifespan of the camera or damage the battery.
- Do not use or store the camera in dusty, dirty, or sandy areas, as its components may be damaged.

- Do not expose the lens to direct sunlight for extended periods.
- Download all pictures and remove the batteries from the camera if you are going to store the camera for long periods.
- Do not use abrasive cleansers, alcohol-based, or solvent-based cleaners to clean the camera. Wipe the camera with a slightly damp soft cloth.

About this manual

This manual provides you with instructions on how to use your GE digital camera. Every effort has been made to ensure that the contents of this manual are accurate, but General Imaging Company reserves the right to make changes without notice.

Symbols used in this manual

Throughout this manual, the following symbols are used to help you locate information quickly and easily.



Indicates the useful information to know.



Indicates the precautions to be taken while operating the camera.

CONTENTS

WARNING	i	Turning on and off	13
SAFETY PRECAUTIONS	ii	Using the Mode Button	14
Precautions of Waterproof Function	iii	Setting date/time and language.....	15
BEFORE YOU START	1	Setting the Date and Time	15
Preface.....	1	Setting the Language	16
Copyright.....	1	About the LCD screen	17
Trademarks	1	BASIC OPERATION	18
Safety information	1	Shooting in Auto mode.....	18
About this manual.....	2	Using the zoom function.....	18
Symbols used in this manual.....	2	Using the flash	19
CONTENTS.....	3	Using the self-timer/Multiple shots	19
GETTING READY	7	Using Macro mode	20
Unpacking.....	7	Exposure compensation	20
Camera Views	8	Advanced function menu (quick menu setup).....	21
Charging the battery.....	10	WB (White Balance).....	21
Inserting the battery	11	ISO	22
		Quality.....	23

Size	24	Snow	33
Color.....	25	Fireworks	33
USING THE MODES	26	Museum	33
LCD Screen display.....	26	Night landscape.....	33
Still shooting mode display	26	Portrait.....	33
Video shooting mode display.....	28	Children.....	33
Playback mode display.....	29	Leaf.....	33
Auto Scene mode (ASCN).....	30	Sunset.....	33
Landscape Mode.....	31	Glass	33
Portrait mode	31	Landscape	33
Night Portrait.....	31	Night portrait.....	33
Backlit Portrait.....	31	Stabilization.....	33
Night Landscape Mode.....	31	Underwater Movie Mode	34
Macro Mode	31	Underwater Picture Mode	35
Auto Mode	31	Panorama.....	35
Scene mode (SCN).....	32	Face Detection	37
Sport	32	Smile Detection.....	38
Indoor	32	Blink Detection.....	39

PLAYBACK	40	Expo Metering (Exposure Metering).....	52
Viewing photos and videos	40	Playback menu.....	53
Using zoom on playback (for still pictures only).....	42	Mode.....	53
Using the Delete button.....	43	Protect.....	53
USING THE MENUS	44	Delete	54
Still menu	44	DPOF (Digital Print Order Format).....	55
AF mode (Auto-Focus mode).....	45	Trim.....	56
AF-assist beam.....	45	Resize.....	56
Continuous AF.....	46	Rotate.....	57
Expo Metering (Exposure Metering).....	46	Slideshow.....	58
Continuous shot.....	47	Red-eye removal	58
Date Imprint.....	48	Setup menu.....	59
Quick Review.....	48	Mode.....	59
Digital Zoom.....	49	Beep	60
Slow Shutter.....	49	Format Memory.....	60
Blink Detection	50	LCD Brightness	61
Movie menu	51	Power Saver	61
Continuous AF.....	52	World time.....	62

Date/Time.....	62
Language.....	62
File Numbering.....	63
Copy to Card (Copy internal memory to memory card).....	63
Reset Settings.....	64
FW Version (Firmware version).....	64
Video system.....	65

CONNECTIONS 66

Connecting to a PC.....	66
Setting the USB mode.....	66
Transferring files to your PC.....	66
Connecting to a PictBridge compatible printer.....	67
Setting the USB mode.....	67
Connecting the camera and printer.....	70
Using the PictBridge menu.....	71
Print with date.....	71
Print without date.....	72

Print index.....	73
Print DPOF.....	74
Exit.....	74

APPENDICES 75

Specifications: G5WP.....	75
Error messages.....	79
Troubleshooting.....	81

GETTING READY

Unpacking

Your package should contain the camera model you purchased along with the following items. If anything is missing or appears to be damaged, please contact your vendor.



Rechargeable Lithium-ion battery



Warranty card



Quick start guide



Wrist strap

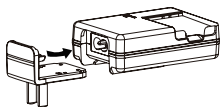

Battery charger

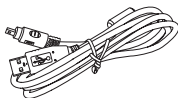

USB cable

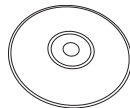

CD-ROM

Camera views

Front View

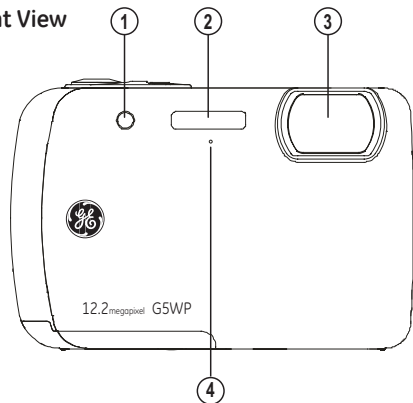

Back View

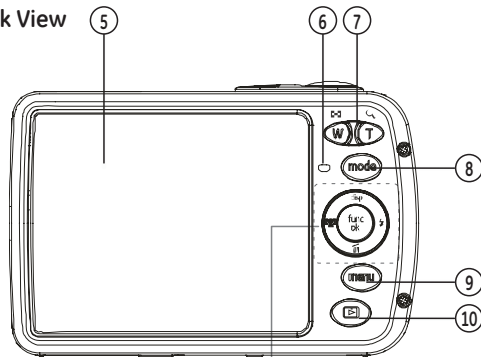

Right View

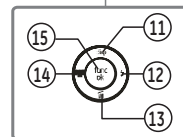
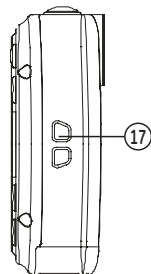

Top View

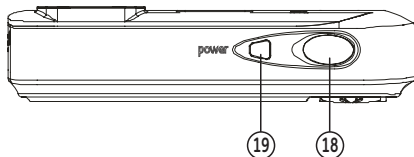

Bottom View

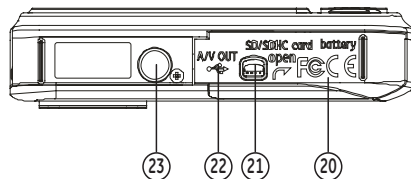

Left View

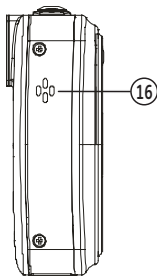



1	AF Assist/Timer Indicator	13	Delete Button/Down Button
2	Flash Lamp	14	Face Detection/Left button
3	Lens	15	Function/OK Button
4	Microphone	16	Speaker
5	LCD Screen	17	Wrist Strap
6	Status Indicator	18	Shutter Button
7	Zoom Button	19	Power Button
8	Mode Selection Button	20	Card Slot/Battery Compartment
9	Menu Button	21	Battery cover Latch
10	Playback Button	22	USB/AV Port (Battery cover must be opened for access)
11	Disp/Up Button	23	Tripod Socket
12	Flash Mode/Right Button		

Charging the battery

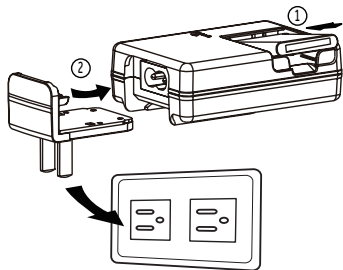
1. Place the battery into the charger as shown.
2. Plug the one end of the connecting cable (plug adapter) into the charger base (the plug adapter may vary in different countries, please subject to the actual object).
3. Plug the other end of the connecting cable into a the wall outlet.



 Leave the battery to charge until the charger light turns green. (To maximize battery life, the first charge should be at least 4 hours)

 The charger is for indoor use only.

Insert the Battery and SD/SDHC Card (not included)

1. Open the battery compartment.

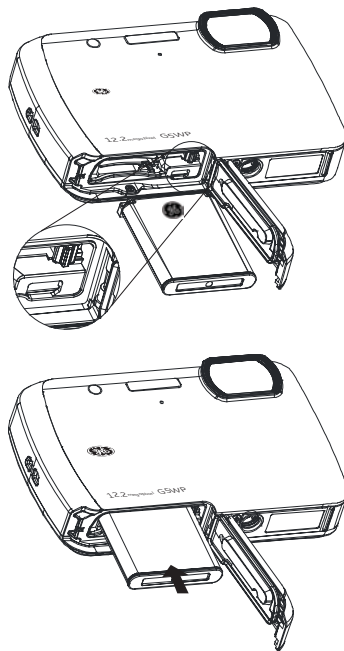
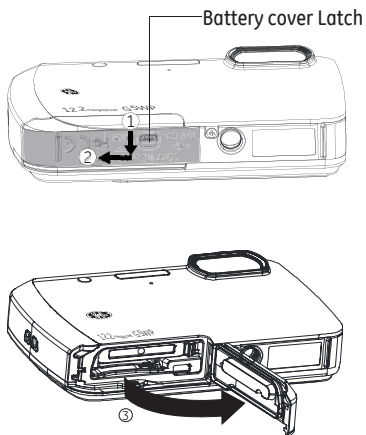





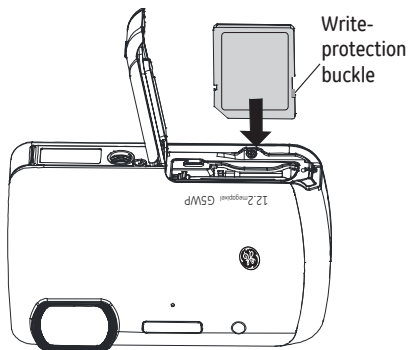

2. Insert the battery while observing the correct polarity. Use the side of battery to press down the stopper as shown, allowing the battery to be inserted properly.

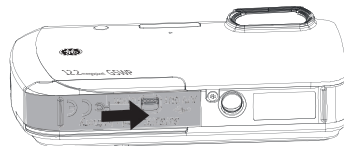
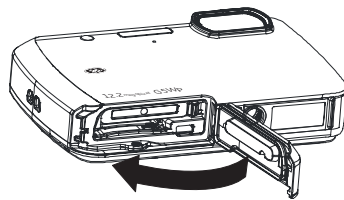
3. Insert an SD/SDHC card (not included) into the memory card slot as shown.



4. Close the battery compartment.



-  Battery capacity decreases with usage.
-  Optional SD/SDHC cards are not included. The use of 64MB to 16GB memory cards from recognized manufacturers such as SanDisk, Panasonic and Toshiba is recommended for reliable data storage.
-  To remove the SD/SDHC card, open the battery compartment and gently push the card downward to release it. Pull the card carefully.
-  Do not open the battery door underwater
-  Make sure the camera is completely dry before opening the battery compartment.

Turning on and off



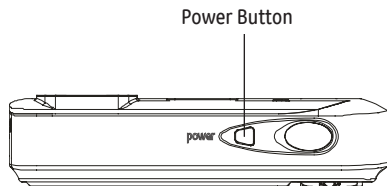



Press the Power button to turn the camera on. To turn off the camera, press the Power button again.



When the camera is turned on, it will be at the same shooting mode based on the last use. You can press the Mode button to select a different one after it is on. When using the camera for the first-time, the language setting page will appear.

Using the Mode Button

The GE camera provides a convenient Mode Button that allows you to switch between different modes with ease. Press Left/Right button to choose the mode, press  to select. All the available modes are listed as follows:



Mode Name	Icon	Description
Auto mode		Switch to take still pictures in automatic mode.
Manual mode		Switch to take still pictures in manual mode, where many camera settings can be configured. (Recommended for advanced users only)
ASCN mode		In the "ASCN" mode, different scene conditions are detected intelligently and the most suitable settings will be automatically selected.
Scene mode	SCN	Switch to use a preset scene mode for taking still pictures. There are 14 scenes in total.
Underwater Movie mode		Switch to record videos underwater.
Underwater Picture mode		Switch to take still pictures underwater.
Panorama mode		Switch to capture a sequence of shots and stitch them together into a panoramic photo.
Movie mode		Switch to record videos.

Setting date/time and language

To set the language, date, and time, go to the following setup options in the **Setup** menu.

- Date / Time
- Display language

To access the **Setup** menu, do the following:

1. Press **Power** to turn the camera on.
2. Press the  button, switch between different pages of Camera Setup menu by using the Left/Right button to select the corresponding camera setting menu.
3. Press the  button to confirm the setting.

Setting the Date and Time

1. Use the **Up/Down** button to select **Date/Time** on the **Camera Setup 1**. Then press the **Right** button to enter the setting.
2. Press the **Left/Right** to highlight each field and use the **Up/Down** to adjust the value.
3. Press the  button to confirm the setting.

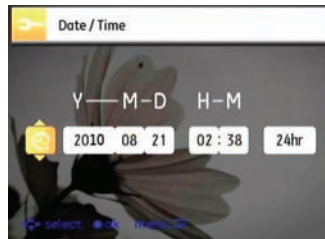

Setting the Language

1. Use the **Up/Down** button to go to the **Language** on the Camera Setup 2. Then press the **Right** button to enter the setting.
2. Use the **Left/Right** buttons to select the desired language.
3. Press the  button to confirm the setting.



The Date/Time and Language setup will automatically appear when the camera is turned on the first time.



About the LCD screen

When you turn the camera on, various icons are shown on the LCD screen to indicate the current camera settings and status. To learn more about the displayed icons, see “LCD Screen display” on page 26.

LCD Screen notes:

High-precision technology had been used to manufacture the LCD screen so that most of the pixels are operational for use. However, there may be some minute points (black, white, red, blue or green) that constantly appear on the LCD screen. These points are normal in the manufacturing process and the recording is not affected in any way.



If the LCD monitor is damaged, take particular care with the liquid crystal in the monitor. If any of the following situations arise, take the urgent action indicated.

- If liquid crystal comes in contact with your skin, wipe the area with a cloth and then wash thoroughly with soap and running water.
- If liquid crystal gets into your eye, flush the affected eye with clean water for at least 15 minutes and then seek medical assistance.
- If liquid crystal is swallowed, flush your mouth thoroughly with water. Drink large quantities of water and induce vomiting. Then seek medical assistance.

BASIC OPERATION

Shooting in Auto mode

Auto mode is the easiest mode to take photos. While operating in this mode, the camera automatically optimizes your photos for best results.

To start shooting, do the following:

1. Press **Power** to turn the camera on.
2. In the Mode menu, select the **Auto mode** ().
3. Compose your picture on the LCD screen and press the Shutter button halfway to focus on the subject.
4. When the subject is in focus, the green colored focus frame appears on the center of the LCD screen.
5. Press **Shutter** fully to capture the image.

Using the zoom function

Your camera is equipped with two types of zoom: optical zoom and digital zoom. Press the **Zoom** button on either the Wide or Tele position of the camera to zoom Wide or Tele on your subject while taking pictures.

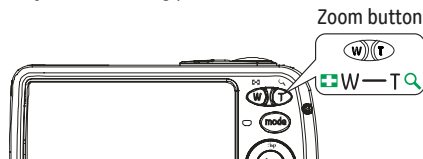







Zoom indicator (See "Digital Zoom" on page 49)

When the optical zoom factor reaches its maximum value, it stops momentarily. Keep pressing down the Tele position () and the zoom will switch over to digital zoom automatically.





Using the flash

Press the Right/Flash button to go to the flash setting menu. Press Up/Down button to switch between the six flash modes.

-  **Flash: Auto**
Camera flash fires automatically based on existing light conditions.
-  **Flash: Red-eye reduction**
The camera fires a brief flash before the picture is taken to reduce red-eye effects.
-  **Flash: Forced flash**
Flash always fires.
-  **Flash: Forced off**
Flash is turned off.
-  **Flash: Slow Synchro**
This allows you to take pictures of people at night that clearly show both your subjects and the night time backdrop.
-  **Flash: Red-Eye + Slow Synchro**
Use this mode for slow synchro shots with red-eye reduction.



Using the self-timer/Multiple shots

To enable the self-timer, press the Right/Flash button then Left/Right button to go to the self-timer setting menu. Choose between the 2-sec, 10-sec, Continuous Shot, or Self-timer Off by using the Up/Down button.

-  **Self-timer: 2 sec**
A single picture is shot 2 seconds after the shutter button is pressed.
-  **Self-timer: 10 sec**
A single picture is shot 10 seconds after the shutter button is pressed.
-  **Self-timer: Unlimited**
Pictures are shot continuously when the shutter button is pressed down based on the Continuous Shot settings in the menu. (See "Continuous Shot" on page 47).
-  **Self-timer: Off**
Disable the self-timer.

Using Macro mode

In Macro Mode, you can capture subject details at close range; press the Left/Right button to go to the Macro Mode after getting into the setting menu by pressing the Right/Flash button. Switch between Macro and Macro Off by pressing the Up/Down button.

-  Macro: On
Select this to focus on subjects 6cm from the lens.
-  Macro: Off
Select this option to disable Macro.

Exposure compensation

The exposure compensation allows you to adjust the background brightness to produce the best result of photos. To change the exposure values, do the following:

1. Press the Right/Flash button and Left/Right button to go to the exposure setting menu.

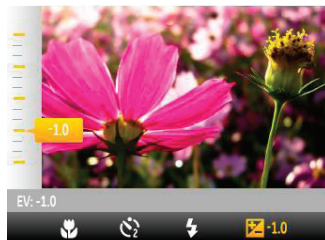

2. Adjust the image exposure between EV -2.0 and EV +2.0 with the Up/Down button.

Advanced function menu (Quick menu setup)

WB (White Balance)









The white balance allows user to adjust the color temperature under different light source to ensure faithful color reproduction.

(The WB setting is only available when the camera is in the **M** Manual mode).

To set the white balance, do the following:

1. Press the  button to enter the **Function** menu. Make sure the **WB** function is selected.



2. Use **Up/Down** navigation buttons to select the setting you want. The following options are available:
 -  WB: Auto
 -  WB: Daylight
 -  WB: Cloudy
 -  WB: Fluorescent
 -  WB: Fluorescent CWF
 -  WB: Incandescent
 -  WB: Manual (press the Shutter button to detect WB)
3. Use the **Left/Right** buttons to select other options, or press the  button once to confirm your selection and exit the current menu.

ISO

The ISO function allows you to set the sensitivity of the camera sensor based on the brightness of the scene. To improve the performance in darker environments, a higher ISO value is required. On the other hand, a lower ISO value is needed when in bright conditions.

(The ISO setting is only available when the camera is in the  **Manual mode**).

To set the ISO value, do the following:

1. Press the  button to enter the **Function** menu.
2. Use the **Left/Right** navigation buttons to go to the **ISO** function.



3. Use the **Up/Down** navigation buttons to select the desired ISO value from **Auto**, **64**, **100**, **200**, **400**, **800**, or **1600**.
4. Use the **Left/Right** buttons to select other options, or press the  button once to confirm your selection and exit the current menu.

 Pictures at higher ISO will naturally have more noise than those at lower ISO.





Quality

The quality setting adjusts the compression ratio of the images. Higher quality settings give better photos, but will take up more memory space.

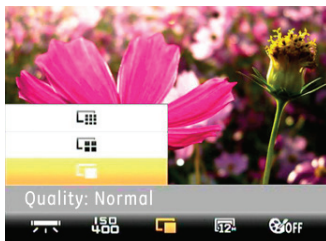
To set the image quality, do the following:

1. Press the  button to enter the **Function** menu.
2. Use the **Left/Right** navigation buttons to go to the **Quality** function.



3. Use the **Up/Down** navigation buttons to select a desired setting. Three options are available.
 -  Quality: Best
 -  Quality: Fine
 -  Quality: Normal
4. Use the **Left/Right** buttons to select other options, or press the  button once to confirm your selection and exit the current menu.
5. The number of available shots remaining is displayed on the LCD.



When you turn on the camera for the first time, its default image quality is **Best**.

Size

The size setting refers to the image resolution in pixels. A higher image resolution allows you to print that image in larger sizes without degrading the image quality.

To set the image size, do the following:

1. Press the  button to enter the **Function** menu.
2. Use the **Left/Right** navigation buttons to go to the **Size** function.

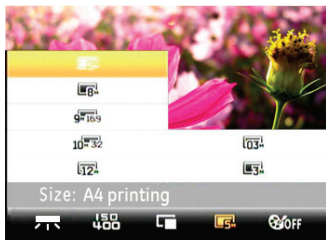

3. Use the **Up/Down** navigation buttons to select desired resolution.
4. Press the  button to confirm your setting.

5. The number of available shots is displayed on the screen.



The bigger the number of recorded pixels is, the better the image quality becomes. As the number of recorded pixels becomes smaller, you will be able to record more frames on a memory card.

Color

The color setting allows you to add artistic effects directly when taking shots. You can try different color tones to alter the mood of your pictures.

(The Color setting is only available when the camera is in the **M** Manual mode).

To set the image color, do the following:

1. Press the  button to enter the **Function** menu.
2. Use the **Left/Right** navigation buttons to go to the **Color** function.



3. Use **Up/Down** to select an option. The following options are available:

-  **OFF** Color: Auto
-  **BW** Color: Black & White
-  **SE** Color: Sepia
-  **VI** Color: Vivid

4. Press the  button to confirm your setting.

USING THE MODES

LCD Screen display

Still shooting mode display

Mode:

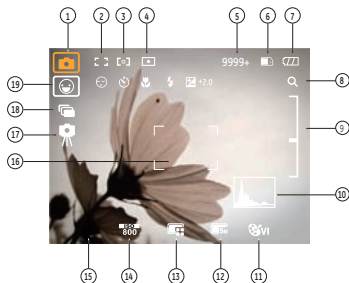

1 Shooting Mode Icons

	Auto mode		Manual mode
	ASCN mode		Scene mode
	Panorama mode		Underwater picture mode

2 Continuous AF

3 AF mode

Single-AF

Multi-AF

4 Expo Metering





Spot

Center





Ai AE

5 Remaining number of pictures

6 Memory card/built-in memory



- 7 Battery status
- 8 WT ratio (displayed only when zoom is activated)
- 9 Zoom
- 10 Histogram
- 11 Picture color (adjustable only in  Manual Mode)
- 12 Image size
- 13 Image quality
- 14 ISO value (adjustable only in  Manual Mode)
- 15 White balance (adjustable only in  Manual Mode)
- 16 Focus frame
- 17 Slow shutter warning icon
- 18 Continuous shot
- 19 Face detection icon
- 20 Blink detection
- 21 Self-timer
 -  2-sec
 -  10-sec
- 22 Macro Mode

23 Flash Mode

-  Flash: Auto
-  Flash: Red-eye reduction
-  Flash: Forced flash
-  Flash: Forced off
-  Flash: Slow Synchro
-  Flash: Red-Eye + Slow Synchro

24 Exposure

Video shooting mode display

Mode :  

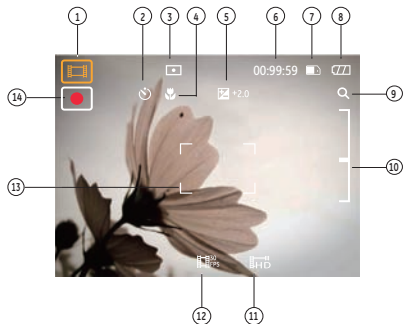

1 Shooting Mode icons

2 Self-timer

3 Expo Metering



Spot



Center



AiAE

4 Macro Mode

5 Exposure

6 Remaining time for video recording

7 Memory card/built-in memory

8 Battery status

9 WT ratio (displayed only when zoom is activated)

10 Zoom

11 Video resolution

12 Video quality

13 Focus frame

14 Recording Status Icon



Recording standby



Recording



For optimal video shooting, it is recommended that the SD card be used. If you shoot videos with the limited built-in memory as a result of short video recording, there may be picture jitter and noise.



During video shooting, the optical zoom is fixed but the highest 4.5x digital zoom is still available.

Playback mode display

Mode: ▶

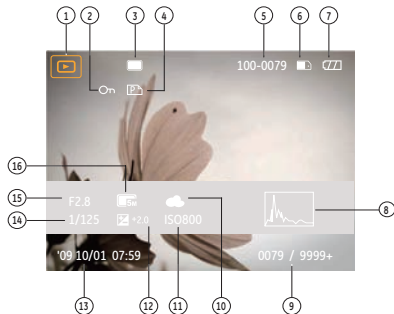

- 1 Play Mode icon
- 2 File protection icon
- 3 Picture file icon
- 4 DPOF file icon
- 5 Picture number
- 6 Memory card/built-in memory
- 7 Battery status
- 8 Histogram
- 9 Memory space (this picture/total number of pictures)
- 10 White balance
- 11 ISO value
- 12 Exposure compensation
- 13 Recording date and time
- 14 Shutter speed
- 15 Aperture value
- 16 Image size

Auto Scene mode (ASCN)







In the "ASCN" mode, different recording conditions are detected intelligently and the most suitable settings will be automatically selected. With "ASCN" you can always take good pictures easily.

To use "ASCN"

1. Press the  button, select "ASCN" with the Left/Right button, and the LCD screen will show the figures as below.



2. Hold the camera steadily and aim at the subject. The optimum scene mode will be identified automatically.
3. Press the Shutter button halfway down to focus.
4. Press the Shutter button all the way down to take the picture.

Icon	Mode name	Icon	Mode name
	Landscape Mode		Night Landscape Mode
	Portrait mode		Macro Mode
	Night Portrait		Auto Mode
	Backlit Portrait		

Landscape Mode

For landscapes, ASCN will automatically adjust the exposure to match the background.

Portrait mode

For portraits, ASCN will automatically adjust the exposure and skin tones to give clear pictures.

Night Portrait

When you shoot portraits at night, or in low light conditions, ASCN will automatically adjust the exposure for people and night scenes.

Backlit Portrait

When the sun or any other light source is behind you, ASCN will automatically adjust the foreground exposure to produce good pictures.

Night Landscape Mode

For night scenes, ASCN will automatically increase the ISO value to compensate for low light.

Macro Mode

To capture object detail for close-ups, ASCN will automatically adjust the focus.

Auto Mode

The camera will automatically adjust the exposure and focus to ensure good pictures.















Manual Scene mode (SCN)

In **Manual Scene mode**, you can select from a total of 14 scene types to match your needs. You just need to select the right scene for the occasion and the camera will automatically adjust to the optimal settings for you.

Press the  button, select the Scene Mode menu with the Left/Right button, and the LCD screen will show the figure as below.



Select a scene using the Left/Right button and press the  button.

Icon	Mode Name	Icon	Mode Name
	Sport		Indoor
	Snow		Fireworks
	Museum		Night Landscape
	Portrait		Children
	Leaf		Sunset
	Glass		Landscape
	Night Portrait		Stabilization Mode

Sport

For fast-moving subjects. Capture sharp action shots without blur.

Indoor

For indoors. Reduce blur and improve color accuracy.

Snow

For snow scenes.Reproduce natural and clear white scenes.

Fireworks

For fireworks at night.Slow shutter speed adjusted for brilliant images.

Museum

For museum or flash-free area. Retain color and reduce blur.

Night landscape

For night scenes. Use of tripod is recommended.

Portrait

For portraits. Soften skin tones and bring subject into focus.

Children

For kids and pets.Flash is disabled for eye protection.

Leaf

For plants. Capture brilliant shots of greenery and blossoms.

Sunset

For sunsets. Capture subjects in strong sunlight.

Glass

For objects behind transparent glass.

Landscape

For landscapes.Vivid reproduction of green and blue.



Night portrait

For portraits against night time scenery.

Stabilization

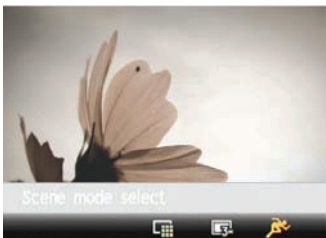
Reduces blurred image caused by hand shake or target object movement during shoot.



1. After selecting the scene type, press the  button to activate.
2. To select a different scene type, press the  button to enter the main function menu. Then press it again to return to the to Scene selection menu.



The main function menu also allows you to adjust the image quality and image size. Please refer to the "Advanced Functions Menu" section on page 21 for detailed instructions.

Underwater movie Mode

When you are in the water, you can select Underwater Movie Mode in the Mode Selection menu to shoot underwater videos.

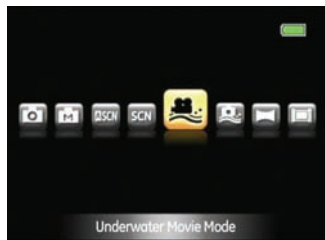

Press the  button, select Underwater Movie Mode with the Left/Right button, and press the  button for confirmation.



-  Do not go deeper than 5 meters below the water surface.
-  Do not use your camera underwater for more than 2 hours.

Underwater picture mode

When you are in the water, you can select Underwater Picture Mode in the Mode Selection menu to take pictures under water.

Press the  button, select Underwater Picture Mode with the Left/Right button, and press the  button for confirmation.

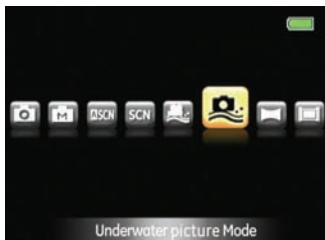





 Do not go deeper than 5 meters below the water surface.

 Do not use your camera under water for more than 2 hours.

Panorama

Panorama mode allows you to create a panoramic picture. The camera will automatically compose a panoramic picture using the individual shots that you take.

Follow these steps to create a panoramic picture:

1. Press  button and use Left/Right button to select Panorama Synthesis Mode, then press  button to confirm it.
2. Press  button to enter into photo setting screen, press Up/Down button to enter into Panorama Synthesis Mode, then select Auto or Manual mode. Press  to confirm it.



3. Use the **Left/Right** buttons to specify the direction of picture taking, and then in 2 seconds the panoramic sequence will commence automatically.
4. Compose the first view of the panoramic picture on the LCD screen and press the Shutter button to capture.
5. Following are different steps for the Auto Mode and Manual Mode selected for the Panorama Mode in the Photo Setup.

When Using Auto Mode:

After the first shot is taken, two target icons will appear on the left and right side of the LCD screen. Pan the camera and the circle icon on the screen will move towards the square frame icon. When the circle icon and square frame become green once they overlap, the camera will capture the next picture automatically. Repeat the same step for the third picture to finish the stitching.

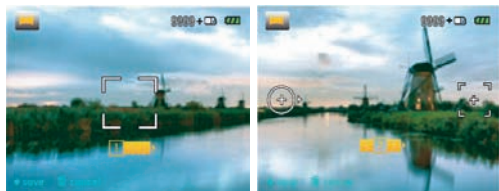



When Using Manual Mode:

After the first shot is taken, the semi-transparent image of the first shot will appear at the edge of the screen. You can use this image to compose your picture before you press the shutter button to capture and finish manual stitching.



6. The camera will then stitch the pictures into a panorama automatically.
7. Press the playback button to enter Playback mode and review the panorama result.

-  After taking a Panoramic picture press the func/ok button to save and exit or press the Delete button to cancel and exit.
-  Pictures cannot be deleted, nor the zoom adjusted until the series is finalized.
-  Panorama Mode can stitch 2 or 3 maximum pictures.

Face Detection

The Face Detection mode will detect faces of persons during picture shooting so that the faces will be clearer.

1. In Shooting Mode, press the Left/Face Detection button to turn on the Face Detection and an icon (😊) appears on the LCD.
2. Hold the camera securely, and point the camera towards the subject to start the face detection process. When the camera detects a face, a white rectangular frame will be drawn around the face. (Note: For best results, the face of the subject should be relatively large on the LCD screen, and the subject should be facing the camera as front on as possible.)
3. Press **Shutter** halfway to focus on the subject.
4. Press **Shutter** fully to capture the image.
5. Press the Left/Face Detection button to turn off Face Detection.

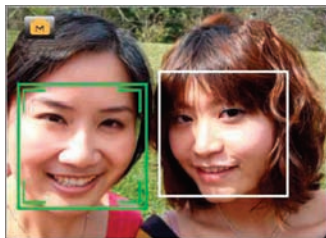

Smile Detection

With the camera's new "Smile Detection" feature, which automatically detects and captures a person smiling, you'll never miss a smile.

1. In Shooting Mode, press the Left/Face Detection button to turn on Smile Detection and an icon (😊) appears on the LCD.
2. Point the camera at the subject until the subject's face is detected and bracketed by a square box. Press the shutter button all the way down and release the shutter button. The camera will now 'wait' for the subject to smile.
3. When the subject smiles, the camera will automatically release the shutter and capture the photo.
4. To turn off the Smile Detection, press the Left/Face Detection button again.



A face must be detected by the camera in order for smile detection to function correctly.



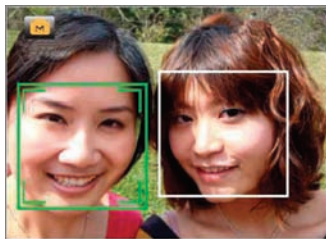

For optimal detection results, the subject should be framed to occupy most of the screen space.



Blink Detection

The Blink Detection feature is on by default, and after taking each photo, a warning message will pop up if a blink had been detected in the photo.

1. In photography modes, press the button  to enter the Photo menu.
2. Switch between different Photo Setup menus and Camera Setup menus using the Left/Right button, and select the "Blink Detection" setting using the Up/Down button.
3. Use the Right navigation buttons to enter the submenu, and select "On" option.
4. Press the button  to confirm the setting and exit the menu.
5. The "Blink detection" indicator appears on the LCD.
6. Press the Shutter button fully to capture the image. If someone has blinked, the camera will show blink detection warning message right after.



A face must be detected by the camera in order for smile detection to function correctly.



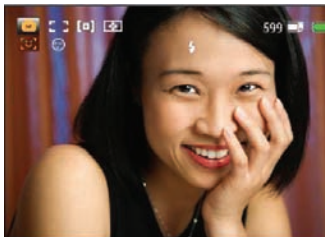

For optimal detection results, the subject should be framed to occupy most of the screen space.



Viewing photos and videos

To view the captured photos and video clips on the LCD screen:

1. Press  button to go to the **Playback** mode. The last recorded photo or video clip is displayed.
2. Use the **Left/Right** navigation buttons to scroll through the photos or video clips stored in the internal memory or memory card.
3. To play a selected video clip, press the  button to enter the movie playback mode.

During video playback, the operating instructions will appear on the screen. Press the Left/Right button, and press the  button for confirmation.

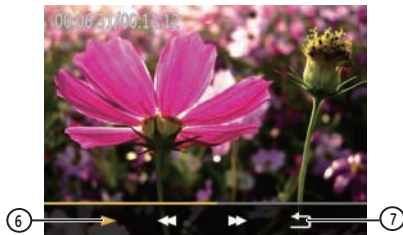

During video playback, you can press the Up/Down button to adjust the volume.

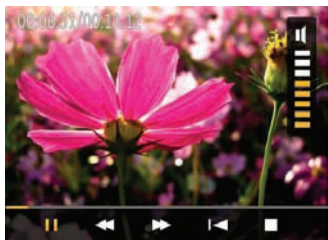

The operating instruction icons are as follows.

- | | | | |
|---|--------------|---|------|
| 1 | Pause | 5 | Stop |
| 2 | Rewind | 6 | Play |
| 3 | Fast Forward | 7 | Back |
| 4 | First Frame | | |

Thumbnail view

When in **Playback** mode, press the Zoom button at the Wide position ( W) once to display the thumbnail of photos and video clips on the screen.

1. Use the Zoom button to switch between the 2x2, 3x3, and 4x4 thumbnail display.
2. Use **Up/Down/Left/Right** to select a photo or video clip to view.





If the  indicator appears on the LCD, then a movie file is currently being displayed.



Press the  button to restore a preview icon to its original image size.

Using zoom playback (for still pictures only)

The zoom buttons can also be used during playback. This allows you to magnify photos up to (2~8)X.

1. Press  button to go to the **Playback** mode.
2. Use the **Left/Right** navigation buttons to select a photo to magnify.
3. Press the Tele button () once to zoom in.
4. Use the zoom buttons to zoom in and out. The zoom indicator and pan box appear on the screen.



5. Use the navigation buttons to pan across the image.
6. Press the  button to return the image to its original scale.



Movie images cannot be magnified.

Using the Delete button

In Playback Mode, you can press the Down/Delete button to delete pictures or videos.

To delete pictures or videos:

1. Press  button to go to the Playback Mode.
2. Select a picture or video clip you want to delete with the Left/Right button.
3. Press the Down/Delete button and the delete screen appears.

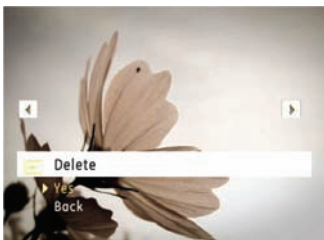

4. Select Yes or Back with Up/Down button and press the  button for confirmation.



Erased photos/video clips cannot be recovered.



Please refer to page 54 for instructions on the delete menu options.

USING THE MENUS

Still menu

Mode:    SCN  

In any of the above Still Modes, press the  button to go to the Still menu.

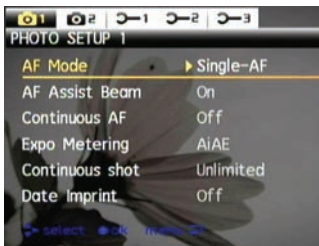

To adjust each setting:

1. In the Still menu, switch between different Photo Setup or Camera Setup pages using the Left/Right button, to select the page with the function you want to adjust and press the Down button.



2. Press the Up/Down buttons to select the function.
3. Press the Right button to go to the submenu.



4. Press Up/Down button to select an option or press the Left or  button to return to the menu.
5. Press the  button for confirmation and exit the menu.

 After selecting a function, you can press the Up button to return to the Still menu for other Photo Setup or Camera Setup pages. Or you can press the Down button several times to move to the next setup menu page.

Refer to the following pages for more details about each setting.

AF mode (Auto-Focus mode)

Use this setting to control the auto-focus mechanism while taking pictures.



AF-assist beam

Use this setting to aid the focus in dark conditions. Select **On** to turn on the AF assist beam, or **Off** to disable the function.



Two options are available:

- **Single-AF:** The focus frame appears on the center of the LCD screen to focus on the subject.
- **Multi-AF:** The camera automatically focuses the subject in a wide area to find the focus point.

Continuous AF

After Continuous AF is turned on, the camera will adjust focus automatically in response to any camera or subject movement.



Expo Metering (Exposure Metering)

Use this setting to select an area for the exposure to be obtained.



Three options are available:

- Spot
- Center
- AiAE (Artificial Intelligence AE)

Continuous shot

Use this setting to perform continuous shooting. Once in this mode, you must continuously hold down the Shutter button to use this function.

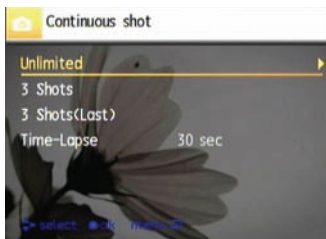

Four options are available:

- **Unlimited:** Press and hold the shutter to shoot continuously until you release the shutter or when the memory card has run out of space.
- **3 shots:** Capture up to 3 consecutive pictures.
- **3 shots (Last):** Capture pictures continuously until the shutter button is released but only the last 3 shots are recorded.
- **Time-Lapse:** Automatically capture pictures in a pre-defined interval.

 The flash is designed not to work in this mode in order to enable quick succession of shots.

 Continuous shot can only be selected in Self-timer mode.

Date Imprint

Include a date/time stamp in the photo image.



- Off
- Date
- Date / time

Quick Review

This setting refers to the quick photo review immediately after taking a picture. The picture stays on the LCD screen for an adjustable period of time.



Four options are available:

- Off
- 1 sec
- 2 sec
- 3 sec

Digital Zoom

Use this setting to enable or disable the digital zoom function. When disabled, only the optical zoom is enabled.



Digital Zoom indicator

- **Off:** gray color.
- **On:** reddish color.



Slow Shutter

In Slow shutter mode, the shutter will remain open as long as the shutter button is pressed. This gives you complete control over the duration of exposure. (The slow shutter mode is available only in **M** manual mode.)



- **Manual :** To set a long exposure time between 2~30 sec.



The use of tripod is recommended for prolonged exposure.



Blink Detection

The Blink Detection feature is on by default, and after taking each photo, a warning message will pop up if a blink was detected in the photo.



- Off
- On

Movie menu

Mode:  

In any of the above Movie Modes, press the  button to go to the corresponding Movie menu.



To configure each setting:

1. In the Movie menu, switch between the Movie Setup or different Camera Setup pages using the Left/Right button, select the page with the function you want to adjust and press the Down button.



2. Press the Up/Down button to select the function and press the Right button to go to the submenu.



3. Press the Up/Down button to select an option or the Left or  button to return to the menu.
4. Press the  button for confirmation and exit the menu.

Refer to the following pages for more details about each setting.

Continuous AF

After Continuous AF is turned on, the camera will adjust focus automatically in response to any camera or subject movement.



Expo Metering (Exposure Metering)

Set metering mode for various lighting conditions.



Three options are available:

- Spot
- Center
- AiAE (Artificial Intelligence AE)

Playback menu

Mode : 

In Playback mode, press the  button to enter the Playback menu.



Please refer to the following sections for detailed instructions on the various menu options.



Protect

To prevent any pictures or videos from being accidentally erased, use this setting to lock one or all of the files.



To protect/unprotect a picture or video:

1. Switch to the Playback mode. Press the Left/Right button to find the picture or video you want to protect. Go to the Playback menu, select the page with the protection settings and press the Down button.
2. Press the Up/Down button to select the protection setting option and press the Right button to go to the submenu.

3. Use the **Up/Down** navigation buttons to select **One** to protect this picture/video, or select **All** to protect all pictures/videos in the internal memory or memory card. Then press the **Right** navigation button to enter the submenu.
4. Use **Up/Down** button to select **Yes**, press  button to lock the displayed photo or image (press  button again to unlock), press **Up/Down** button to select **Return** to return to the Playing menu.
5. A key () icon will appear on the top of the screen to indicate that the picture/video is protected.
6. Select **Reset** on the Protection setting to cancel protection for all files that have been placed in the protected mode.

Delete

There are two ways to delete files: (please note that a file cannot be recovered once it is deleted.)



- **Delete One:**

1. On the **Delete** setting, select **Delete One** and then press the **Right** button.
2. Using the **Left/Right** buttons, locate the photo or movie file to be deleted. Select **Yes** (to delete file) or **No** (to return to the previous menu) using the **Up/Down** buttons, then press the  button to confirm.

- **Delete All:**

1. On the Delete setting, select **Delete All** and then press the **Right** button.
2. Using the **Up/Down** buttons, select **Yes** (to delete all files) or **No** (to cancel and return to the previous menu).



The “🔒” indicator means a file is protected. File protection must be removed first before a file can be deleted.



Deleting files will cause DPOF settings to be reset.

DPOF (Digital Print Order Format)

DPOF allows you to record your selection of pictures that you would like to print, and will save your selection in the memory card, so that you can simply hand your memory card to a photo kiosk without having to tell them in person which photos you would like to print.



Trim

The Trim setting allows you select an area of the photo you want to keep and then save it as a new photo.

To trim a picture:

1. Select the **Trim** setting from the **Playback** menu.
2. Using the **Left/Right** buttons, locate the photo that you want to crop and have it displayed on the LCD.
3. Use the zoom buttons and navigation buttons to adjust the trimming box to fit the location and size of the new picture.

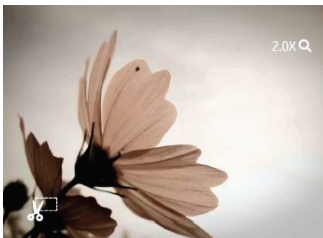

4. Press the **Shutter** button to save what you see on the LCD screen as a new picture, or the **(menu)** button to cancel and return to the **Playback** menu.

Resize

This setting allows you to resize a picture to a specified resolution, and saves it as a new picture.

1. Select the **Resize** setting from the **Playback** menu as described previously.

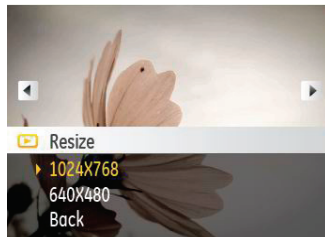

2. Use the **Left/Right** navigation buttons to select a picture to resize.

- Use the **Up/Down** navigation buttons to select a resolution (**1024X768** or **640X480**) to resize the image or **Back** to cancel and return to the **Playback** menu.
- Press the  button to confirm the setting.

 Resizing an image creates a new file that contains the image in the size you select. The file with the original image also remains in memory.

 If the message “The image cannot be edited.” appears, it means that the current image cannot be resized.

Rotate

You can use this setting to change the picture orientation of the picture.

- Select the **Rotate** setting from the **Playback** menu as described previously.
- Use the **Left/Right** navigation buttons to select a picture to rotate.
- Use the **Up/Down** navigation buttons to select the direction for rotation or **Back** to cancel and return to the **Playback** menu.



- Press the  button to confirm the setting.

Slideshow

This setting allows you to view all the stored pictures as a slideshow.

1. Select the **Slideshow** setting from the **Playback** menu.
2. Use the **Up/Down** navigation buttons to select **Effect**, **Interval** time, or **Repeat** and use the **Left/Right** navigation buttons to adjust the setting.



3. Use the **Up/Down** navigation buttons to select **Start** to run the slideshow or **Cancel** to return to the **Playback** menu.
4. Press the **Func OK** button to confirm the setting.

Red-eye Reduction

Use this setting to remove red-eyes in your photos.

1. Select the **Red-eye Reduction** setting from the **Playback** menu as described previously.
2. Use the **Left/Right** navigation buttons to select the image for which the red-eye needs to be removed.
3. Use the **Up/Down** navigation buttons to select **Yes** to fix the selected image or **Back** to cancel and return to the **Playback** menu.





4. Press the **Func OK** button to confirm the setting.



For best results, the face of the subject should be relatively large on the LCD screen, the subject should be facing the camera as front on as possible, and the red eyes should be as large as possible.

Setup menu

Mode :        

The Setup menu for the camera is available in all modes. Each menu page can be selected by pressing the  button and switching between menus with the Left/Right button.



To adjust the settings:

1. Select the menu page with the function you want to adjust and press the Down button.

2. Switch between different functions with the Up/Down button.
3. Press the **Right** button to enter the submenu.



After selecting a function option, you can press the Up button to return to the menu for other Camera Setup pages. Or you can press the Down button to switch to the next menu page.

Refer to the following pages for more details about each setting.

Beep

Use this setting to adjust the volume of beep when buttons are pressed and change the tones for shutter, buttons, self-timer, and power-on/power-off.

To change this setting:

1. Select the **Beep** setting from the **Setup** menu as described previously.
2. Use the **Up/Down** navigation buttons to switch between volume, shutter tone, key tone, self-timer tone, and power tone fields.



3. Press the Right button, press the Up/Down button to adjust volume and change tone, and press the  button to confirm setting.

Format Memory

Please note: formatting enables you to delete all contents in the memory card and built-in memory, including protected photo and movie files.

To use this setting:

1. Select the **Format Memory** setting from the **Setup** menu as described previously.
2. Use Up/Down button to select Yes or No, then press  button to confirm the setting.

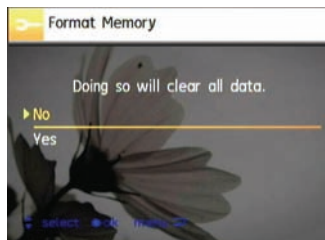

3. The current media is formatted.

LCD Brightness

Use this setting to adjust the brightness of your LCD screen.

1. Select the **LCD Brightness** setting from the **Setup** menu as described previously.
2. Select auto or adjust the brightness level using the Left/Right button, and press the  button to confirm the setting.

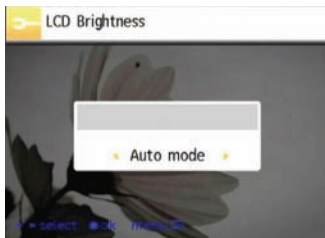

Power Saver

This setting allows you to save power and get the maximum possible running time for your battery. Follow the steps below to turn off the LCD screen and camera automatically after a period of inactivity.

1. Select the **Power Save** setting from the **Setup** menu as described previously.
2. Press the Up/Down button to select the power items for the screen and camera and press the Right button.

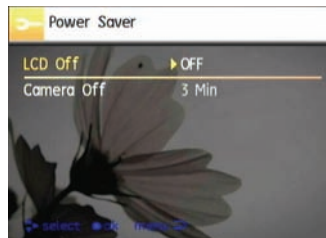



3. Press the Up/Down button to adjust the selected item. Both items have the following options:

- Turn off the LCD:
30 sec, 1 min, 2 min, and off.
 - Turn off the camera:
3 min, 5 min, 10 min, and off.
4. Press the  button to confirm.

Zone

The Zone setting is a useful function on your overseas trips. This feature enables you to display the local time on the LCD screen while you are overseas.

1. Select the **Zone** setting from the **Setup** menu as described previously. The world time screen appears.
2. Use the **Up/Down** navigation buttons to switch between the hometown () and travel destination () fields.
3. Use the **Left/Right** navigation buttons to select a city close to the desired time zone. Then press the  button to confirm.



Date/Time

See “Setting the Date and Time” section on page 15.

Language

See “Setting the Language” section on page 16.

File Numbering

After you take a picture or video clip, the camera will save it as file that ends with a serial number. You can use this item to choose whether the file is serially numbered or begins with 1 and is saved in another folder on the memory card.

1. Select the File Numbering setting in the camera setting menu.
2. Select the option with the Up/Down button and press the  button for confirmation.

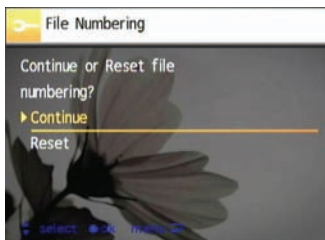

Copy to Card (Copy internal memory to memory card)

Use this setting to copy the files stored in the internal memory to the memory card.

1. Select the Copy to memory card setting from the Setup menu as described previously.
2. Use the Up/Down navigation buttons to select Yes or No. Then press the  button to confirm.

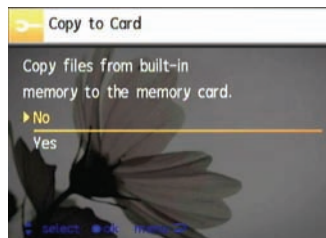

Reset Settings

Use this setting to restore the camera to its default settings.

1. Select the **Reset** setting from the **Setup** menu as described previously.
2. Use the **Up/Down** navigation buttons to select **Yes** or **No**. Then press the  button to confirm.



FW Version (Firmware Version)

Use this setting to view the current camera firmware version.

1. Select the **FW Version** setting from the **Setup** menu as described previously.
2. If SD card contains a new version of firmware, please upgrade accordingly as necessary.



To update to the latest firmware version, you can go to the following website: <http://www.ge.com/digitalcameras>.

Video System

Use this setting to determine your video system in the current area.

1. Select the **Video System** setting from the **Setup** menu as described previously.
2. Use the **Up/Down** navigation buttons to select **NTSC** or **PAL**. Then press the  button to confirm.

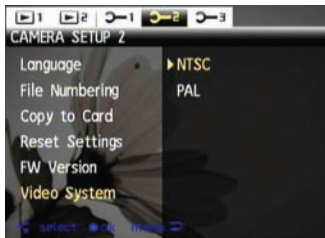

The video output signal can be switched to NTSC or PAL to accommodate different regional standards. The appropriate setting will vary between regions.

NTSC: USA, Canada, Taiwan, Japan, etc.

PAL: Europe, Asia (excluding Taiwan), Oceania, etc.

Note: The TV output will not display properly if an incorrect video system is selected.

Connecting to a PC

Use the USB cable and ArcSoft software (CD-ROM) supplied with your camera to copy (transfer) pictures to a computer.

Setting the USB mode

Since the camera's USB port can be set to connect with either a PC or a Printer, the following steps will allow you to ensure that the camera is correctly configured to connect with a PC.

1. Go to the camera setting menu, select USB connection with the Up/Down button, and press the Right button.
2. Use the Up/Down navigation buttons to select PC.
3. Press the  button to confirm the setting.



Transferring files to your PC

The computer will automatically detect the camera as a removable drive. Double-click **My Computer** icon on the desktop to locate the removable drive and to copy the folders and files in the drive to a directory on your PC as you would copy any typical folder or file.

By using the USB cable, you can transfer the captured photos and videos to a PC. Follow the steps below to connect the camera to a PC.

1. Start a computer to which ArcSoft software has been installed.
2. Make sure both the camera and PC are turned on.
3. Connect one end of the supplied USB cable to the USB/AV OUT port on your camera.
4. Connect the other end of the cable to an available USB port on your PC.

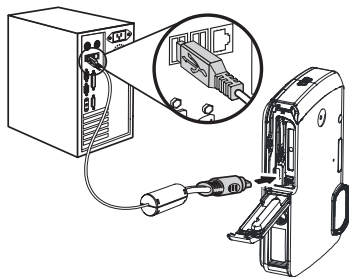

5. Disconnect the camera once transfer is completed.

If the USB option is set to [PC] :

Turn the camera off and disconnect the USB cable.

If the USB option is set to [PC (PTP)] :

Remove the camera from the system as described below before turning the camera off and disconnecting the USB cable.

Windows operating system (Windows 2000, Windows XP, Windows Vista, Windows 7.)

Click the [Safely remove the hardware] icon and remove the USB connector according to the appeared menu.



Macintosh

Drag the untitled icon to the Trash. ("Untitled")



Connecting to a PictBridge compatible printer



PictBridge allows printing images from a memory card in a digital camera directly to a printer, regardless of brand. To find out if a printer is PictBridge compatible, simply look for the PictBridge logo on the packaging or check

the manual for specifications. With the PictBridge function on your camera, you can print the captured photos directly with a PictBridge compatible printer using the supplied USB cable, without the need for a PC.

Setting the USB mode

Since the camera's USB port can be set to connect with either a PC or a Printer, the following steps will allow you to ensure that the camera is correctly configured to connect with a Printer.

1. Go to the camera setting menu, select USB connection with the Up/Down button, and press the Right button.
2. Use Up/Down to select Printer.

3. Press the  button to confirm the setting.



-  After the camera is reset, it will switch to PC mode automatically from USB mode.

Connecting the camera and printer.

1. Make sure both the camera and printer are turned on.
2. Connect one end of the supplied USB cable to the USB port on your camera.
3. Connect the other end of the cable to the USB port on the printer.

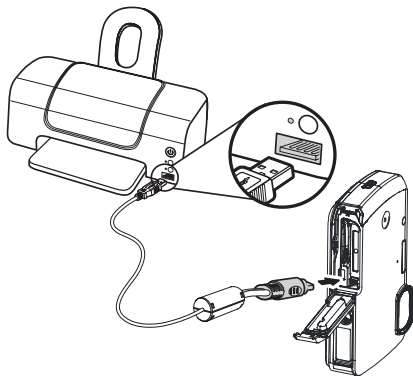

If the camera is not connected to a PictBridge compatible printer, the following error message appears on the LCD screen.

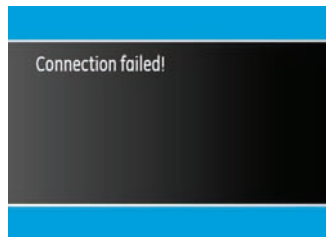

-  The above error message would also appear if the USB mode were set incorrectly, in which case you should disconnect the USB cable, check the USB mode settings, ensure that the Printer is turned on, and then try connecting the USB cable again.

Using the PictBridge menu

After setting the USB mode to Printer, the **PictBridge** menu appears.



Select a menu item with the Up/Down button and press the Right button or  button to enter the item.

Refer to the following sections for more detailed information on each setting.

Print with date

If you have set the date and time of your camera, the date record would be saved with the photos you take. You can print the photos with date by following the steps below.

1. Select **Print with date** from the **PictBridge** menu. The following screen appears.



2. Use the **Left/Right** navigation buttons to scroll through the photos.

- Use the **Up/Down** navigation buttons to select the number of prints for the current displayed photo.
- Press the  button and the following screen appears.

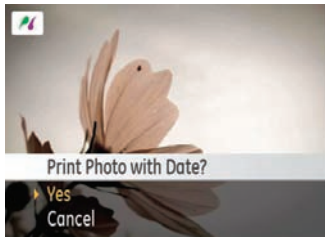

- Select **Yes** to confirm printing, or **No** to cancel. Then press the  button.

Print without date

Use this setting to print the photos without dates on them.

- Select **Print without date** from the PictBridge menu. The following screen appears.



- Use the **Left/Right** navigation buttons to scroll through the images.
- Use the **Up/Down** navigation buttons to select the number of prints for the current displayed image.
- Press the  button and the following screen appears.

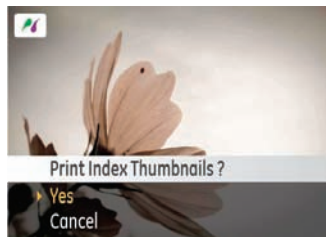
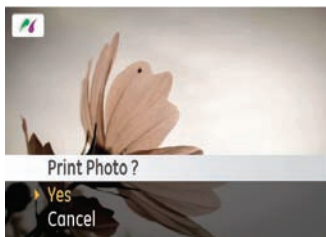

5. Select **Yes** to confirm printing, or **No** to cancel. Then press the  button.

2. Select **Yes** to confirm the printing, or **No** to cancel. Then press the  button.

Print index

You can use this setting to print all indexes to show all the photos currently in your camera.

1. Select **Print index** from the **PictBridge** menu. The following screen appears.

Print DPOF (Digital Print Order Format)

To use DPOF printing, you must make the selection of photos for printing using the DPOF settings before hand. See “DPOF” section on page 55.

1. Select **Print DPOF** from the **PictBridge** menu. The following screen appears.

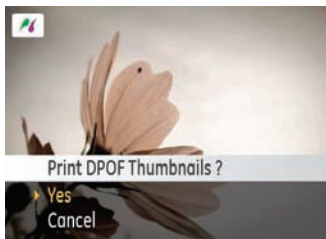

2. Select **Yes** to confirm the printing, or **No** to cancel. Then press the  button.

Exit

To exit the **PictBridge** menu, select **Exit**. The “Remove USB cable” message will be displayed.



Disconnect the USB cable from the camera and printer.

Specifications : G5WP



Design and specifications are subject to change without notice.

Effective Image Sensor Pixels		12.2 Megapixels
Image Sensor		12.4 Megapixels [1/2.3" (CCD)]
Lens	Focal Length F =	6.75mm (Wide) ~ 27mm (Tele)
	35mm film equivalent	38mm (Wide) ~ 152mm (Tele)
	F number	F3.5 (Wide) ~ F5.15 (Tele)
	Construction	14 elements in 11 groups
	Optical Zoom	4X
	Focusing Range	Normal: (Wide) 60cm ~ ∞, (Tele) 80cm ~ ∞; Macro: (Wide) 6cm ~ 80cm, (Tele) 80cm ~ ∞
Anti-Handshake		Electronic Image Stabilization
Digital Zoom		4.5X digital zoom (Combined Zoom: 18X)

Number of Recording Pixels	Still Image	12MP, 10MP(3:2), 9MP(16:9), 8MP, 5MP, 3MP, 0.3MP
	Movie	720x480pixels: 30fps/15fps, 320x240pixels: 30fps/15fps
Image Compression		Best, Fine, Normal
DCF, DPOF (Ver1.1) Support		Yes
File Format	Still Image	Exif 2.2 (JPEG)
	Movie	Quick Time Motion JPEG, Audio: G.711 [Monaural]
Shooting Modes		Auto, Manual, Auto-Scene, Scene (Sport, Indoor, Snow, Fireworks, Museum, Night Landscape, Portrait, Children, Leaf, Sunset, Glass, Landscape, Night Portrait, Stabilization), Underwater Movie, Underwater Picture, Panorama, Video
Smile Detection		Yes
Blink Detection		Yes
Face-Detection		Yes
Red-eye Removal		Yes

Pan-Capture Panorama	Yes
Supports underwater recording	Yes
Supports underwater shooting	Yes
LCD Display	2.7 inch (230,400 pixels) LTPS (low-temperature polycrystalline silicon) TFT color LCD
ISO Sensitivity	Auto, ISO64/100/200/400/800/1600
AF Method	Single AF, Multi-AF (TTL 9-point), AF Assist Light (On/Off)
Light Metering Method	Artificial Intelligence AE (AiAE), Center-weighted Average, Spot (Fixed to center of frame)
Exposure Control Method	ProgramAE (AE-lock available)
Exposure Compensation	±2 EV in 1/3 Step increments
Shutter Speed	4 ~ 1/2000 second (Manual 30 s)
Continuous Shooting	Approx. 1.39 fps (Large/Fine mode)
Playback Modes	Single Photo, Index (4/9/16 thumbnails), Slide Show, Movie (Slow-Motion possible), Zoom (Approx. 2X~8X), Audio, Histogram Display
White Balance Control	Auto (AWB), Daylight, Cloudy, Fluorescent , Fluorescent CWF, Incandescent, Manual

Internal Flash (Shooting Range)	Auto/Red-Eye Reduction/Forced Flash/No Flash/Slow Synchro/Red-Eye Reduction+Slow Synchro
	Gno. 5.5 EV (ISO 100)
	Shooting Range Wide: Approx. 0.5m~4.4m / Tele: Approx. 0.8m ~ 3.0m (ISO 800)
Recording Media	Internal Memory: 16MB
	SD Card/SDHC Card (Up to 16GB support)
Other Features	PictBridge, ExifPrint Support, Multi-language Support
Jacks	USB2.0/AV-OUT (Integrated Proprietary Connector)
Power	Rechargeable Lithium-ion Battery GB-10 (D016), 3.7V 700mAh
Shooting Capability (Battery Performance)	Approx. 180 shots (based on CIPA standards)
Operation Environment	Temperature: 0~40°C, Humidity: 0~90%
Dimensions (W x H x D)	95.8mm x 62mm x 20.5mm
Mass	Approx. 125g (Body only)

Error messages

Messages	Explanation
No card	<ul style="list-style-type: none">• The memory card is not inserted.
Card error	<ul style="list-style-type: none">• The memory card is not formatted.
Card full	<ul style="list-style-type: none">• The memory card is full and cannot store any new images.
Write protect	<ul style="list-style-type: none">• The memory card is write-protected.
Picture error	<ul style="list-style-type: none">• The picture is not captured correctly.• The picture is damaged.
No picture	<ul style="list-style-type: none">• There are no images in the memory card or in the internal memory.
Lens error	<ul style="list-style-type: none">• The lens is probably stuck and the camera will power off automatically.
System error	<ul style="list-style-type: none">• Unexpected error encountered.
Image cannot be saved	<ul style="list-style-type: none">• The write protection switch in the memory card is set to the "LOCK" position.
Out of the range	<ul style="list-style-type: none">• When pictures were taken in Panorama mode, the direction of movement was incorrect or the angle was outside the range of the internal settings.

Messages	Explanation
Card is not formatted, format?	<ul style="list-style-type: none"> • Confirm whether the memory card should be formatted.
This image cannot be deleted	<ul style="list-style-type: none"> • The picture or video you are trying to delete is protected.
Cannot record movie	<ul style="list-style-type: none"> • The write protection switch in the memory card is set to the "LOCK" position.
Warning!! Camera recording, please wait.	<ul style="list-style-type: none"> • No other actions allowed to perform during video/audio recording.
Warning!! Battery exhausted.	<ul style="list-style-type: none"> • The battery is out of charge.
This file cannot be played back	<ul style="list-style-type: none"> • The picture format cannot be recognized by the camera.
No connection	<ul style="list-style-type: none"> • The camera is not connected to the printer correctly.
Print error	<ul style="list-style-type: none"> • There is a problem with camera or printer.
Cannot print	<ul style="list-style-type: none"> • Check that the printer is out of paper or out of ink. • Check if the printer has a paper jam.

Troubleshooting

Problem	Possible causes	Solution
Camera does not turn on.	<ul style="list-style-type: none">• The battery has run out.• The battery is not inserted correctly.	<ul style="list-style-type: none">• Charge the battery or replace with a fully charged battery.• Re-insert the battery observing the correct polarity.
Camera turns off suddenly during operation.	<ul style="list-style-type: none">• The battery has run out.	<ul style="list-style-type: none">• Charge the battery or replace with a fully charged battery.
The picture is blurred.	<ul style="list-style-type: none">• The lens is dirty.•  appears when taking pictures.	<ul style="list-style-type: none">• Use a soft cloth to clean the lens on your camera• Use the Image Stabilization mode.
Images and video files cannot be saved.	<ul style="list-style-type: none">• The memory card is full.	<ul style="list-style-type: none">• Replace the memory card with a new one.• Delete unwanted images.• Unlock the memory card.

Problem	Possible causes	Solution
No picture is taken when pressing the shutter button.	<ul style="list-style-type: none"> • The memory card is full. • No available space to store the files. • The mode dial is in Playback mode. 	<ul style="list-style-type: none"> • Replace the memory card with a new one or clean off current memory card. • Delete unwanted images. • The memory card is locked.
Images cannot print from the connected printer.	<ul style="list-style-type: none"> • The camera is not connected to the printer correctly. • The printer is not PictBridge compatible. • The printer is out of paper or out of ink. • The paper is jammed. 	<ul style="list-style-type: none"> • Check the connection between the camera and printer. • Use a PictBridge compatible printer. • Load some paper in the printer. • Replace the ink cartridge in the printer. • Remove the jammed paper.

<http://www.ge.com/digitalcameras>

