

Dell™ Inspiron™ 1150 Service Manual

[Before You Begin](#)

[System Components](#)

[Memory, CD or DVD Drive, Modem, and Mini PCI Card](#)

[Hard Drive](#)

[Keyboard](#)

[EMI Shield](#)

[Display](#)

[Palm Rest](#)

[Microprocessor Thermal-Cooling Assembly](#)

[Microprocessor Module](#)

[Speakers](#)



[System Board](#)

[Flashing the BIOS](#)

[Base Plastics](#)

[Pinout Assignments for I/O Connectors](#)

Notes, Notices, and Cautions

-  **NOTE:** A NOTE indicates important information that helps you make better use of your computer.
-  **NOTICE:** A NOTICE indicates either potential damage to hardware or loss of data and tells you how to avoid the problem.
-  **CAUTION:** A CAUTION indicates a potential for property damage, personal injury, or death.

Abbreviations and Acronyms

For a complete list of abbreviations and acronyms, see the *Tell Me How* help file.

If you purchased a Dell™ n Series computer, any references in this document to Microsoft® Windows® operating systems are not applicable.

Information in this document is subject to change without notice.
© 2004 Dell Inc. All rights reserved.

Reproduction in any manner whatsoever without the written permission of Dell Inc. is strictly forbidden.

Trademarks used in this text: *Dell*, the *DELL* logo, and *Inspiron* are trademarks of Dell Inc.; *Microsoft* and *Windows* are registered trademarks of Microsoft Corporation.

Other trademarks and trade names may be used in this document to refer to either the entities claiming the marks and names or their products. Dell Inc. disclaims any proprietary interest in trademarks and trade names other than its own.

Model PP08L

March 2004 Rev. A00

Base Plastics

Dell™ Inspiron™ 1150 Service Manual

 **CAUTION:** Before performing the following procedures, read the safety instructions in your *Owner's Manual*.

 **CAUTION:** To prevent static damage to components inside your computer, discharge static electricity from your body before you touch any of your computer's electronic components. You can do so by touching an unpainted metal surface.

1. Follow the instructions in "[Before Working Inside Your Computer](#)."
2. Remove the [hard drive](#).
3. Remove the [CD or DVD drive](#).
4. Remove the [memory module\(s\)](#).
5. Remove the [modem](#).
6. Remove the [Mini PCI card](#).
7. Remove the [keyboard](#).
8. Remove the [EMI shield](#).
9. Remove the [display assembly](#).
10. Remove the [palm rest](#).
11. Remove the [microprocessor thermal-cooling assembly](#).
12. Remove the [microprocessor](#).
13. Remove the [speakers](#).
14. Remove the [system board](#).

[Back to Contents Page](#)

Before You Begin

Dell™ Inspiron™ 1150 Service Manual

- [Computer Orientation](#)
- [Screw Identification](#)

This chapter provides procedures for removing and installing the components in your computer. Unless otherwise noted, each procedure assumes that the following conditions exist:

- 1 You have performed the steps in "[Turning Off Your Computer](#)" and "[Before Working Inside Your Computer](#)."
- 1 You have read the safety information in your Dell™ *Owner's Manual*.
- 1 A component can be replaced by performing the removal procedure in reverse order.

Recommended Tools

The procedures in this document may require the following tools:

- 1 Small flat-blade screwdriver
- 1 Phillips screwdriver
- 1 Small plastic scribe
- 1 Hex nut driver
- 1 Flash BIOS update program floppy disk or CD

Turning Off Your Computer

 **NOTICE:** To avoid losing data, save and close any open files and exit any open programs before you turn off your computer.

1. Shut down the operating system:
 - a. Save and close any open files, exit any open programs, click the **Start** button, and then click **Turn Off Computer**.
 - b. In the **Turn off computer** window, click **Turn off**.

The computer turns off after the operating system shutdown process finishes.

2. Ensure that the computer and any attached devices are turned off. If your computer and attached devices do not automatically turn off when you shut down your operating system, press and hold the power button for 4 seconds.

Before Working Inside Your Computer

Use the following safety guidelines to help protect your computer from potential damage and to help ensure your own personal safety.

 **CAUTION:** Before you begin any of the procedures in this section, follow the safety instructions in the *Owner's Manual*.

 **CAUTION:** Handle components and cards with care. Do not touch the components or contacts on a card. Hold a card by its edges or by its metal mounting bracket. Hold a component such as a processor by its edges, not by its pins.

 **NOTICE:** Only a certified service technician should perform repairs on your computer. Damage due to servicing that is not authorized by Dell is not covered by your warranty.

 **NOTICE:** When you disconnect a cable, pull on its connector or on its strain-relief loop, not on the cable itself. Some cables have a connector with locking tabs; if you are disconnecting this type of cable, press in on the locking tabs before you disconnect the cable. As you pull connectors apart, keep them evenly aligned to avoid bending any connector pins. Also, before you connect a cable, ensure that both connectors are correctly oriented and aligned.

➡ **NOTICE:** To avoid damaging the computer, perform the following steps before you begin working inside the computer.

1. Ensure that the work surface is flat and clean to prevent the computer cover from being scratched.
2. [Turn off your computer.](#)
3. If the computer is connected to a docking device (docked), undock it. See the documentation that came with your docking device for instructions.

➡ **NOTICE:** To disconnect a network cable, first unplug the cable from your computer and then unplug it from the network wall jack.

4. Disconnect any telephone or telecommunication lines from the computer.
5. Disconnect your computer and all attached devices from their electrical outlets, and then press the power button to ground the system board.

➡ **NOTICE:** To connect a network cable, first plug the cable into the network wall jack and then plug it into the computer.

6. [Remove any installed PC Cards from the PC Card slot.](#)
7. Close the display and turn the computer upside down on a flat work surface.

➡ **NOTICE:** To avoid damaging the system board, you must remove the main battery before you service the computer.

8. Slide and hold the battery-bay latch release on the bottom of the computer, and then remove the battery from the bay.

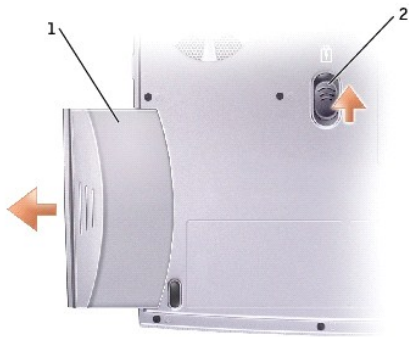

1	battery
2	battery-bay latch release

9. Remove any installed modules, including a second battery, if installed.
10. Remove the [hard drive](#).

Computer Orientation









1	front
2	right
3	back
4	left











Screw Identification

When you are removing and replacing components, photocopy "[Screw Identification](#)" as a tool to lay out and keep track of the screws. The placemat provides the number of screws and their sizes.



M2 x 3 mm M2.5 x 4 mm M2.5 x 5 mm M2.5 x 6 mm M2.5 x 8 mm

<p>Hard Drive Door: (2 each)</p>  <p><i>M2.5 x 5 mm</i></p>	<p>Modem to System Board: (2 each)</p>  <p><i>M2 x 3 mm</i></p>	<p>Optical Drive: (1 each)</p>  <p><i>M2.5 x 8 mm</i></p>
<p>Keyboard to Computer Base: (4 each)</p>  <p><i>M2 x 3 mm</i></p>	<p>EMI Shield: (1 each)</p>  <p><i>M2.5 x 8 mm</i></p>	<p>Display Assembly to Back Panel: (2 each)</p>  <p><i>M2.5 x 5 mm</i></p>

<p>Hinge Bracket to Computer Base: (4 each)</p>  <p>M2.5 x 5 mm</p>	<p>Display Bezel: (5 each)</p>  <p>M2.5 x 5 mm</p> <p>Screw Covers (2 each) Display Bumpers (3 each)</p>	<p>Display Panel: (4 each)</p>  <p>M2 x 3 mm</p>
<p>Display Latch: (2 each)</p>  <p>M2.5 x 5 mm</p>	<p>Top of Palm Rest to Computer Base: (2 each)</p>  <p>M2.5 x 5 mm</p>	<p>Palm Rest to Base Plastics: (12 each)</p>  <p>M2.5 x 8 mm</p>
<p>Palm Rest to Battery Bay: (1 each)</p>  <p>M2.5 x 4 mm</p>	<p>Battery Bay Shield to System Board: (2 each)</p>  <p>M2.5 x 5 mm</p>	<p>System Board to Base Plastics: (2 each, hard drive cage) (2 each, optical drive cage) (2 each, chipset heat sink)</p>  <p>M2.5 x 5 mm</p>
<p>Left Antenna to Hard Drive and Optical Drive Cages (2 each)</p>  <p>M2.5 x 6 mm</p>		

Flashing the BIOS

Dell™ Inspiron™ 1150 Service Manual

- [Flashing the BIOS From a Floppy Disk or a CD](#)
- [Flashing the BIOS From the Hard Drive](#)

If a BIOS update program floppy disk or CD is provided with the new system board, see "Flashing the BIOS From a Floppy Disk or a CD." If you do not have a BIOS update program floppy disk or CD, see "Flashing the BIOS From the Hard Drive."

Flashing the BIOS From a Floppy Disk or a CD

1. Ensure that the AC adapter is plugged in and that the main battery is installed properly.

 **NOTE:** If you use a BIOS update program CD to flash the BIOS, set up the computer to boot from a CD before inserting the CD.

2. Insert the BIOS update program floppy disk or CD, and turn on the computer.

Follow the instructions that appear on the screen. The computer continues to boot and updates the new BIOS. When the flash update is complete, the computer will automatically reboot.

3. Press <F2> during POST to enter the system setup program.
 4. Press <Alt> and <F> to reset the computer defaults.
 5. Press <Esc>, select **Save changes and reboot**, and press <Enter> to save configuration changes.
 6. Remove the flash BIOS update program floppy disk or CD from the drive and restart the computer.
-

Flashing the BIOS From the Hard Drive

1. Ensure that the AC adapter is plugged in, the main battery is properly installed, and a network cable is attached.
2. Boot up the computer.
3. Locate the latest BIOS update file for your computer at support.dell.com.
4. Click **Download Now** to download the file.
5. If the **Export Compliance Disclaimer** window appears, click **Yes, I Accept this Agreement**.

The **File Download** window appears.

6. Click **Save this program to disk** and then click **OK**.

The **Save In** window appears.

7. Click the down arrow to view the **Save In** menu, select **Desktop**, and then click **Save**.

The file downloads to your desktop.

8. Click **Close** if the **Download Complete** window appears.

The file icon appears on your desktop and is titled the same as the as downloaded BIOS update file.





9. Double-click the file icon on the desktop and follow the instructions on the screen.

[Back to Contents Page](#)

Microprocessor Module

Dell™ Inspiron™ 1150 Service Manual

Removing the Microprocessor Module

-  **CAUTION:** Before performing the following procedures, read the safety instructions in your *Owner's Manual*.
 -  **CAUTION:** To prevent static damage to components inside your computer, discharge static electricity from your body before you touch any of your computer's electronic components. You can do so by touching an unpainted metal surface.
 -  **NOTICE:** Press and hold the microprocessor down by applying slight pressure to the center of the microprocessor while turning the cam screw to prevent intermittent contact between the cam screw and microprocessor.
 -  **NOTICE:** To avoid damage to the microprocessor, hold the screwdriver so that it is perpendicular to the microprocessor when turning the cam screw.
1. Follow the instructions in "[Before Working Inside Your Computer](#)."
 2. Remove the [keyboard](#).
 3. Remove the [EMI shield](#).
 4. Remove the [microprocessor thermal-cooling assembly](#).
-  **NOTICE:** When removing the microprocessor module, pull the module straight up. Be careful not to bend the pins on the microprocessor module.
5. To loosen the ZIF socket, use a small, flat-blade screwdriver and rotate the ZIF-socket cam screw counterclockwise until it comes to the cam stop.

The ZIF-socket cam screw secures the microprocessor to the system board. Take note of the arrow on the ZIF-socket cam screw.

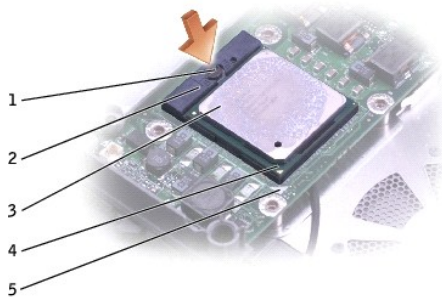

1	ZIF-socket cam screw
2	ZIF socket
3	microprocessor module
4	pin-1 corner of microprocessor
5	triangle on system board

6. Use a microprocessor extraction tool to remove the microprocessor module.

Installing the Microprocessor Module

➡ **NOTICE:** Ensure that the cam lock is in the fully open position before seating the microprocessor module. Seating the microprocessor module properly in the ZIF socket does not require force.

➡ **NOTICE:** A microprocessor module that is not properly seated can result in an intermittent connection or permanent damage to the microprocessor and ZIF socket.

1. Align the pin-1 corner of the microprocessor module so that it points to the triangle on the system board, and insert the microprocessor module into the ZIF socket.

When the microprocessor module is correctly seated, all four corners are aligned at the same height. If one or more corners of the module are higher than the others, the module is not seated correctly.

➡ **NOTICE:** Hold the microprocessor down while turning the cam screw to prevent intermittent contact between the cam screw and microprocessor.

2. Tighten the ZIF socket by turning the cam screw clockwise to secure the microprocessor module to the system board.
3. Wipe the thermal grease off of the microprocessor thermal-cooling assembly with a clean paper towel.
4. Squeeze all of the contents of the thermal grease packet (provided with the kit) on to the microprocessor thermal-cooling assembly.
5. Replace the [microprocessor thermal-cooling assembly](#).
6. Replace the [EMI shield](#).
7. Replace the [keyboard](#).
8. [Update the BIOS](#) using a flash BIOS update program CD.

[Back to Contents Page](#)

Display

Dell™ Inspiron™ 1150 Service Manual

- [Display Assembly](#)
- [Display Bezel](#)
- [Display Panel](#)
- [Display Latch Assembly](#)

Display Assembly

⚠ CAUTION: Before performing the following procedures, read the safety instructions in your *Owner's Manual*.

⚠ CAUTION: To prevent static damage to components inside your computer, discharge static electricity from your body before you touch any of your computer's electronic components. You can do so by touching an unpainted metal surface.

1. Follow the instructions in "[Before Working Inside Your Computer](#)."
2. Remove the [hard drive](#).
3. Remove the [CD or DVD drive](#).
4. Remove the [keyboard](#).
5. Remove the [EMI shield](#).
6. Close the display.
7. From the back of the computer, remove the two M2.5 x 5-mm screws.



8. Open the display assembly approximately 180 degrees, and support the display assembly so that it does not open past this position.
9. Pull straight up on the pull-tab that is attached to the display-feed flex cable to disconnect the cable from the system board.
10. Remove the two M2.5 x 5-mm screws from each hinge bracket.

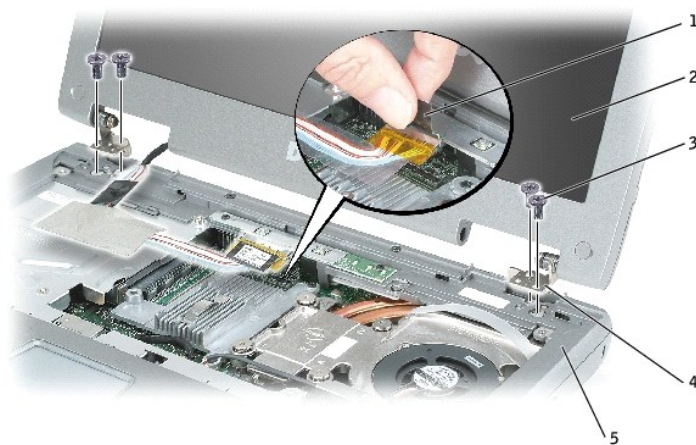

1	pull-tab
2	display assembly
3	M2.5 x 5-mm screws (4)
4	hinge brackets (2)
5	computer base

11. Lift the display assembly up and out of the computer base.

Display

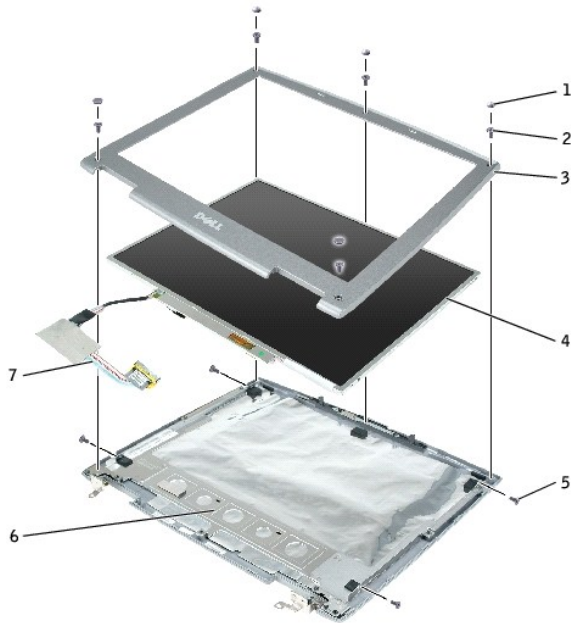

1	screw covers (2) display bumpers (3)
2	M2.5 x 5-mm screws (5)
3	display bezel
4	display panel
5	M2 x 3-mm screws (8)
6	top cover
7	display-feed flex cable

Display Bezel

CAUTION: Before performing the following procedures, read the safety instructions in your *Owner's Manual*.

CAUTION: To prevent static damage to components inside your computer, discharge static electricity from your body before you touch any of your computer's electronic components. You can do so by touching an unpainted metal surface.

1. Follow the instructions in "[Before Working Inside Your Computer](#)."
2. Remove the [keyboard](#).
3. Remove the [display assembly](#).
4. Use a plastic scribe to pry the two screw covers and three display bumpers out of the screw holes located on the front of the bezel.
5. Remove the five M2.5 x 5-mm screws located on the front of the bezel.

➡ **NOTICE:** Carefully separate the bezel from the top cover to avoid damage to the bezel.

6. Starting at the bottom of the display panel, use your fingers to separate the bezel from the top cover and lift the inside edge of the bezel away from the top cover.

Display Panel

Removing the Display Panel

⚠ **CAUTION:** Before performing the following procedures, read the safety instructions in your *Owner's Manual*.

⚠ **CAUTION:** To prevent static damage to components inside your computer, discharge static electricity from your body before you touch any of your computer's electronic components. You can do so by touching an unpainted metal surface.

1. Follow the instructions in "[Before Working Inside Your Computer](#)."
2. Remove the [keyboard](#).
3. Remove the [display assembly](#).
4. Remove the [display bezel](#).
5. Remove the two M2 x 3-mm screws on the each side of the display panel.
6. Lift the display panel out of the top cover.
7. Press in both sides of the top flex-cable connector, and pull the top flex-cable connector away from the display connector.

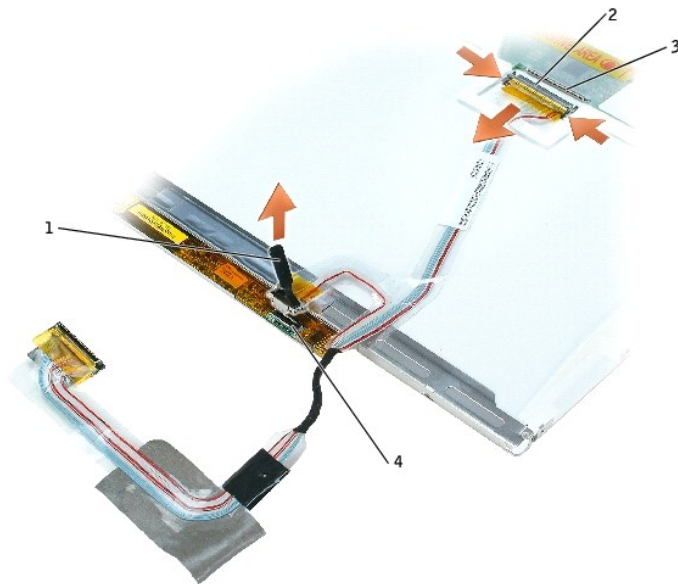

1	pull-tab on bottom flex-cable connector
2	top flex-cable connector
3	display connector
4	inverter connector

8. Use the pull-tab to disconnect the bottom flex-cable connector from the inverter connector.

Installing the Display Panel

1. Connect the top flex-cable connector to the display panel connector.
 2. Connect the bottom flex-cable connector to the inverter connector.
 3. Lay the display panel in the top cover.
 4. Route the display-feed flex cable so that it rests in the notch located in the bottom edge of the top cover.
 5. Replace the four M2 x 3-mm screws that secure the display panel to the top cover.
 6. Replace the [display bezel](#).
-

Display Latch Assembly

Removing the Display Latch Assembly

⚠ CAUTION: Before performing the following procedures, read the safety instructions in your *Owner's Manual*.

⚠ CAUTION: To prevent static damage to components inside your computer, discharge static electricity from your body before you touch any of your computer's electronic components. You can do so by touching an unpainted metal surface.

1. Follow the instructions in "[Before Working Inside Your Computer](#)."
2. Remove the [keyboard](#).
3. Remove the [display assembly](#).
4. Remove the [display bezel](#).
5. Remove the two M2.5 x 5-mm screws that secure the display latch assembly to the top cover.
6. Lift the display latch assembly up and out of the top cover.

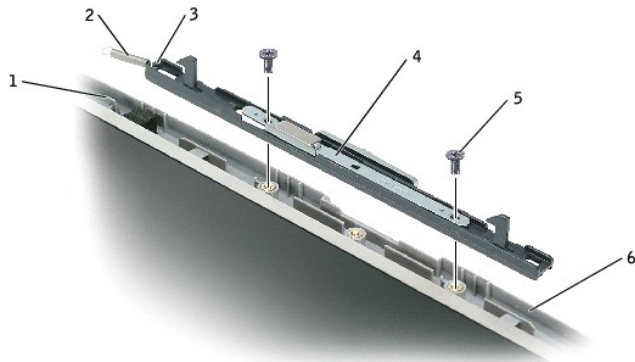

1	spring hook (top cover)
2	spring
3	spring hook (display latch)
4	display latch assembly
5	M2.5 x 5-mm screws (2)
6	top cover

Installing the Display Latch Assembly

1. Attach one end of the spring to the spring hook on the left edge of the display latch, and attach the other end of the spring to the spring hook in the top cover.
 2. Align the screw holes in the display latch assembly with the screw holes in the top cover.
 3. Replace the two M2.5 x 5-mm screws that secure the display latch assembly to the top cover.
-

[Back to Contents Page](#)

EMI Shield

Dell™ Inspiron™ 1150 Service Manual

● [EMI Shield](#)

EMI Shield

⚠ CAUTION: Before performing the following procedures, read the safety instructions in your *Owner's Manual*.

⚠ CAUTION: To prevent static damage to components inside your computer, discharge static electricity from your body before you touch any of your computer's electronic components. You can do so by touching an unpainted metal surface.



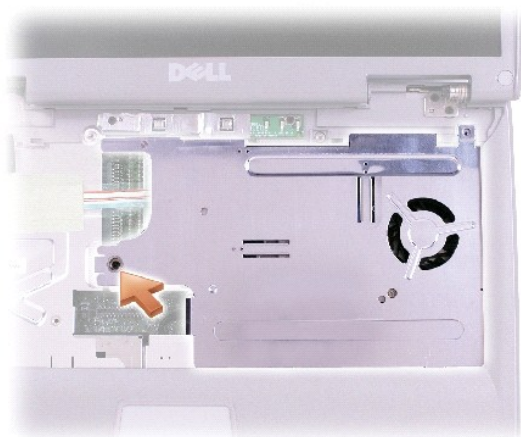

1. Follow the instructions in "[Before Working Inside Your Computer](#)."
2. Remove the [keyboard](#).
3. Remove the one M2.5 x 8-mm screw (labeled "M2.5x8") that secures the EMI shield to the system board, and pull the EMI shield out of the computer base.



Hard Drive

Dell™ Inspiron™ 1150 Service Manual

Removing the Hard Drive

-  **CAUTION:** If you remove the hard drive from the computer when the drive is hot, do not touch the metal housing of the hard drive.
 -  **CAUTION:** Before you begin any of the procedures in this section, follow the safety instructions in your *Owner's Manual*.
 -  **NOTICE:** To prevent data loss, shut down your computer before removing the hard drive. Do not remove the hard drive while the computer is on, in standby mode, or in hibernate mode.
 -  **NOTICE:** Hard drives are extremely fragile; even a slight bump can damage the drive.
 -  **NOTE:** Dell does not guarantee compatibility or provide support for hard drives from sources other than Dell.
1. Follow the instructions in "[Before Working Inside Your Computer](#)."
 2. Turn the computer over, and remove the two M2.5 x 5-mm hard drive screws.

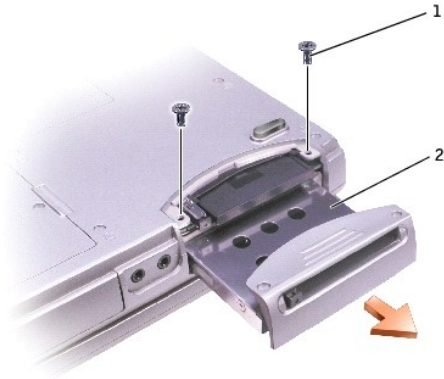

1	M2.5 x 5-mm screws (2)
2	hard drive

-  **NOTICE:** When the hard drive is not in the computer, store it in protective antistatic packaging. See "Protecting Against Electrostatic Discharge" in your *Owner's Manual*.
3. Slide the hard drive out of the computer.

Installing the Hard Drive

-  **CAUTION:** Before you begin any of the procedures in this section, follow the safety instructions in your *Owner's Manual*.

1. Remove the new drive from its packaging.

Save the original packaging for storing or shipping the hard drive.

 **NOTICE:** Use firm and even pressure to slide the drive into place. If you use excessive force, you may damage the connector.

2. Insert the drive into the bay, and push the hard drive until it is fully seated in the bay.
3. Replace and tighten the two M2.5 x 5-mm screws.
4. Use the *Operating System* CD to install the operating system for your computer.
5. Use the *Drivers and Utilities* CD to install the drivers and utilities for your computer.

[Back to Contents Page](#)

Keyboard

Dell™ Inspiron™ 1150 Service Manual

Removing the Keyboard

CAUTION: Before working inside your Dell™ computer, read the safety instructions in your *Owner's Manual*.

CAUTION: To prevent static damage to components inside your computer, discharge static electricity from your body before you touch any of your computer's electronic components. You can do so by touching an unpainted metal surface.

1. Follow the instructions in "[Before Working Inside Your Computer](#)."
2. Use a small flat-blade screwdriver or plastic scribe to lift the notched right edge of the hinge cover, and pry the cover loose from the hinges and computer base.

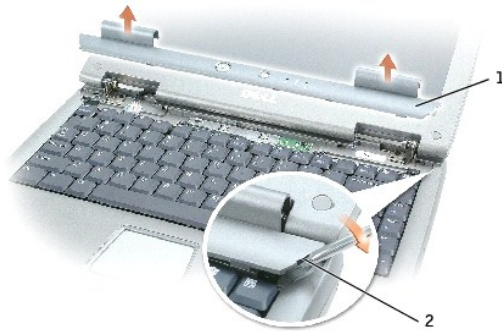

1	hinge cover
2	notched edge

3. Lift the hinge cover up and away from the hinges and computer base.
4. Remove the four M2 x 3-mm keyboard screws.



1	M2 x 3-mm screws (4)
2	keyboard
3	keyboard connector
4	interface connector

➡ **NOTICE:** The keycaps on the keyboard are fragile, easily dislodged, and time-consuming to replace. Be careful when removing and handling the keyboard.

5. Lift the top of the keyboard out of the computer base, and pull the keyboard out at an angle (towards the display).
6. Grasp the keyboard flex cable near the connector, and pull up on the flex cable to disconnect it from the interface connector on the system board.
7. Remove the keyboard from the computer base.

Installing the Keyboard

➡ **NOTICE:** To avoid damage to the connector pins, press the keyboard connector evenly into the interface connector on the system board, and do not reverse the keyboard connector.

1. Connect the keyboard connector of the replacement keyboard to the interface connector on the system board.

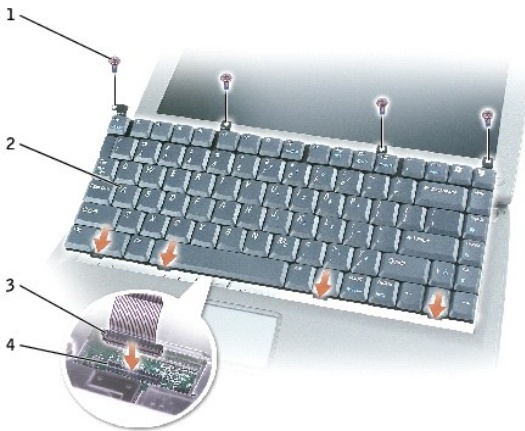

1	M2 x 3-mm screws (4)
2	keyboard
3	keyboard connector
4	interface connector

2. Insert the four securing tabs on the keyboard into their respective slots in the palm rest, and lower the keyboard into the computer base.

Ensure that all four securing tabs are engaged before trying to completely seat the keyboard.

3. Replace the four M2 x 3-mm keyboard screws.
4. To replace the hinge cover, first insert the left side of the hinge cover into the notches. Snap down the hinge cover, and ensure that it is flush with the palm rest.

Palm Rest

Dell™ Inspiron™ 1150 Service Manual

● [Palm Rest](#)

Palm Rest

⚠ CAUTION: Before performing the following procedures, read the safety instructions in your *Owner's Manual*.

⚠ CAUTION: To prevent static damage to components inside your computer, discharge static electricity from your body before you touch any of your computer's electronic components. You can do so by touching an unpainted metal surface.

1. Follow the instructions in "[Before Working Inside Your Computer](#)."
2. Remove the [hard drive](#).
3. Remove the [CD or DVD drive](#).
4. Remove the [keyboard](#).
5. Remove the [EMI shield](#).
6. Remove the [display assembly](#).
7. Turn the computer over and remove the twelve M2.5 x 8-mm screws (not labeled).
8. Remove the M2.5 x 4-mm screw from the battery bay.



9. Turn the computer back over and remove the two M2.5 x 5-mm screws from the top of the palm rest.

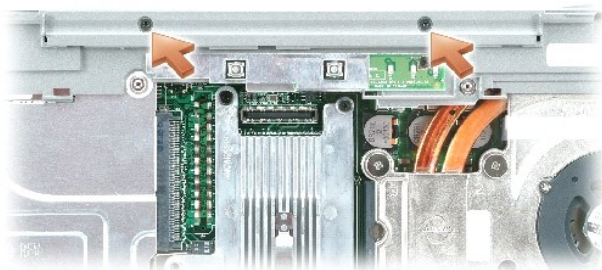

10. Disconnect the touch pad connector from the system board.



➡ **NOTICE:** Carefully separate the palm rest from the base plastics to avoid damage to the palm rest.

11. Starting at the back center of the palm rest, use your fingers to separate the palm rest from the base plastics by lifting the inside edge of the palm rest.

[Back to Contents Page](#)

Pinout Assignments for I/O Connectors

Dell™ Inspiron™ 1150 Service Manual

● [USB Connector](#)

● [Video Connector](#)

USB Connector

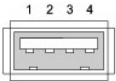

Pin	Signal
1	USB5V+
2	USBP-
3	USBP+
4	GND

Video Connector

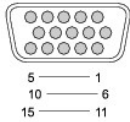

Pin	Signal	Pin	Signal
1	CRT_R	9	5V+
2	CRT_G	10	GND
3	CRT_B	11	MONITOR_DETECT-
4	NC	12	DDC_DATA
5	GND	13	CRT_HS
6	GND	14	CRT_VS
7	GND	15	DDC_CLK
8	GND		

Speakers

Dell™ Inspiron™ 1150 Service Manual

Removing the Speakers

⚠ CAUTION: Before performing the following procedures, read the safety instructions in your *Owner's Manual*.

⚠ CAUTION: To prevent static damage to components inside your computer, discharge static electricity from your body before you touch any of your computer's electronic components. You can do so by touching an unpainted metal surface.

The speakers are located on the left and right corners of the front of the base plastics. Take note of the speaker cable routing so that you can replace the cables properly under or between their routing clips.

1. Follow the instructions in "[Before Working Inside Your Computer](#)."
2. Remove the [hard drive](#).
3. Remove the [CD or DVD drive](#).
4. Remove the [keyboard](#).
5. Remove the [display assembly](#).
6. Remove the [EMI shield](#).
7. Remove the [palm rest](#).
8. Disconnect the speaker connector from the system board.

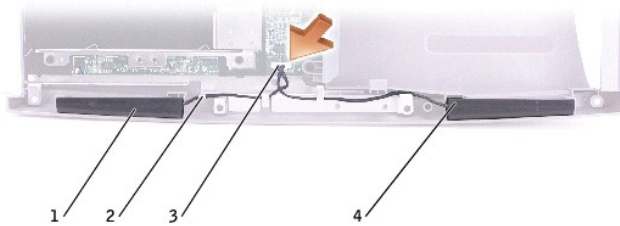

1	left speaker
2	routing clips (3)
3	speaker connector
4	right speaker

➡ NOTICE: Remove the speaker cables from their routing clips with care to avoid damaging the cables.

9. Remove the speaker cables from under or between their routing clips.

➡ NOTICE: Handle the speakers with care to avoid damaging them.

10. Remove the speakers by pulling them straight up and out of the base plastics.

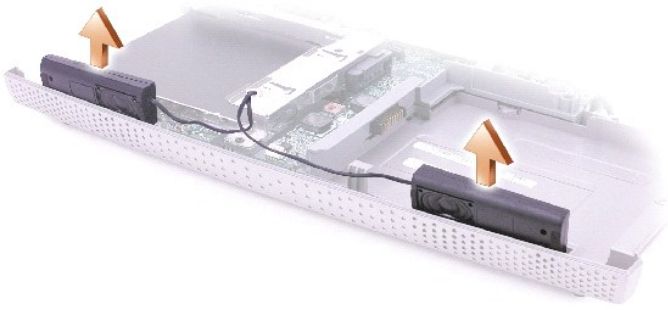

Installing the Speakers

1. Slide the speakers down into the base plastics.

👉 **NOTICE:** Ensure that the speaker cables are under or between their routing clips.

🔍 **NOTE:** Speakers face out in the base plastics holders.

🔍 **NOTE:** The right speaker cable is longer than the left speaker cable.

2. Route the speaker cables under or between their routing clips.
3. Connect the speaker connector to the system board.

[Back to Contents Page](#)

System Board

Dell™ Inspiron™ 1150 Service Manual

Removing the System Board

⚠ CAUTION: Before performing the following procedures, read the safety instructions in your *Owner's Manual*.

⚠ CAUTION: To prevent static damage to components inside your computer, discharge static electricity from your body before you touch any of your computer's electronic components. You can do so by touching an unpainted metal surface.

The system board's BIOS chip contains the Service Tag sequence, which is also visible on a barcode label on the bottom of the computer. The replacement kit for the system board includes a CD that provides a utility for transferring the Service Tag sequence to the replacement system board.

1. Follow the instructions in "[Before Working Inside Your Computer](#)."
2. Remove the [hard drive](#).
3. Remove the [CD or DVD drive](#).
4. Remove the [memory module\(s\)](#).
5. Remove the [modem](#).
6. Remove the [Mini PCI card](#).
7. Remove the [keyboard](#).
8. Remove the [display assembly](#).
9. Remove the [EMI shield](#).
10. Remove the [palm rest](#).
11. Remove the [microprocessor thermal-cooling assembly](#).
12. Remove the [microprocessor](#).
13. Remove the [speakers](#).
14. Remove the two M2.5 x 5-mm screws from the battery bay shield, and remove the shield.

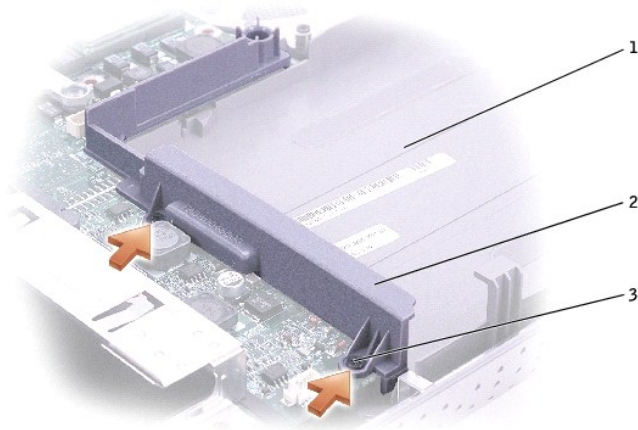

1	battery bay
2	battery bay shield
3	M2.5 x 5-mm screws (2)

15. Remove the two M2.5 x 5-mm system board screws from the hard drive cage.

16. Remove the two M2.5 x 5-mm system board screws from the optical drive cage.
17. Remove the two M2.5 x 5-mm system board screws from the chipset heat sink.

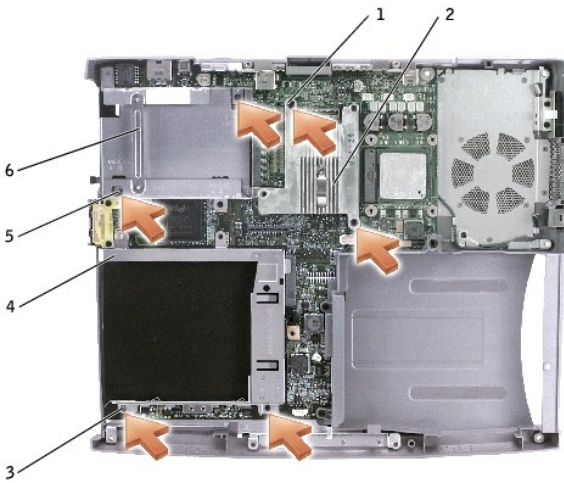

1	M2.5 x 5-mm screws (2)
2	chipset heat sink
3	M2.5 x 5-mm screws (2)
4	optical drive cage
5	M2.5 x 5-mm screws (2)
6	hard drive cage

18. Remove the two M2.5 x 6-mm screws that secure the left antenna to the hard drive and optical drive cages.

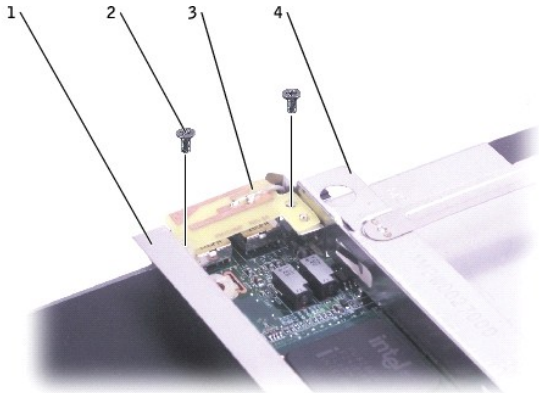

1	optical drive cage
2	M2.5 x 6-mm screws (2)
3	left antenna
4	hard drive cage

19. Remove the two hex nuts that secure the video connector to the base plastics.

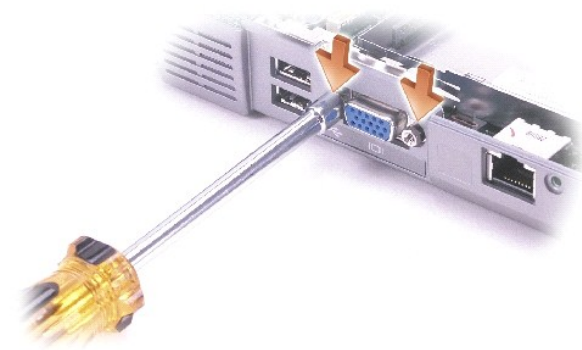

20. Lift the front of the system board out and away from the base plastics.

Installing the System Board

1. Insert the video connector on the replacement system board through the back of the base plastics.
2. Replace the two hex nuts that secure the video connector to the base plastics.
3. Replace the two M2.5 x 6-mm screws that secure the left antenna, which is located between the hard drive and optical drive cages, to the system board.
4. Replace the two M2.5 x 5-mm screws that secure the optical drive cage to the system board.
5. Replace the two M2.5 x 5-mm screws that secure the hard drive cage to the system board.
6. Replace the two M2.5 x 5-mm screws that secure the chipset heat sink to the system board.
7. Replace the battery bay shield, and reinstall the two M2.5 x 5-mm screws that secure the shield to the system board.
8. Replace the [speakers](#).
9. Replace the [microprocessor](#).

➡ **NOTICE:** Before you replace the microprocessor thermal-cooling assembly, wipe the thermal grease off of the assembly with a clean paper towel. Squeeze all of the contents of the thermal grease packet (provided with the kit) on to the microprocessor thermal-cooling assembly.

10. Replace the [microprocessor thermal-cooling assembly](#).
11. Replace the [palm rest](#).
12. Replace the [display assembly](#).
13. Replace the [EMI shield](#).
14. Replace the [keyboard](#).
15. Replace the [Mini PCI card, modem](#), and [memory module\(s\)](#) that you removed from the old system board.
16. Replace the [CD or DVD drive](#).
17. Replace the [hard drive](#).
18. Insert the battery into the battery bay.
19. Connect the AC adapter to the computer and to an electrical outlet.

➡ **NOTICE:** Before turning on the computer, replace all screws and ensure that no stray screws remain inside the computer. Failure to do so may result in damage to the computer.

🔧 **NOTE:** After replacing the system board, enter the computer Service Tag sequence into the BIOS of the replacement system board.

20. Turn on the computer.
21. Insert the CD that accompanied the replacement system board into the appropriate drive, and turn on the computer. Follow the instructions on the screen.

System Components

Dell™ Inspiron™ 1150 Service Manual

CAUTION: Only a certified service technician should perform repairs on your computer. Damage due to servicing that is not authorized by Dell is not covered by your warranty.

NOTICE: Unless otherwise noted, each procedure in this document assumes that a part can be replaced by performing the removal procedure in reverse order.

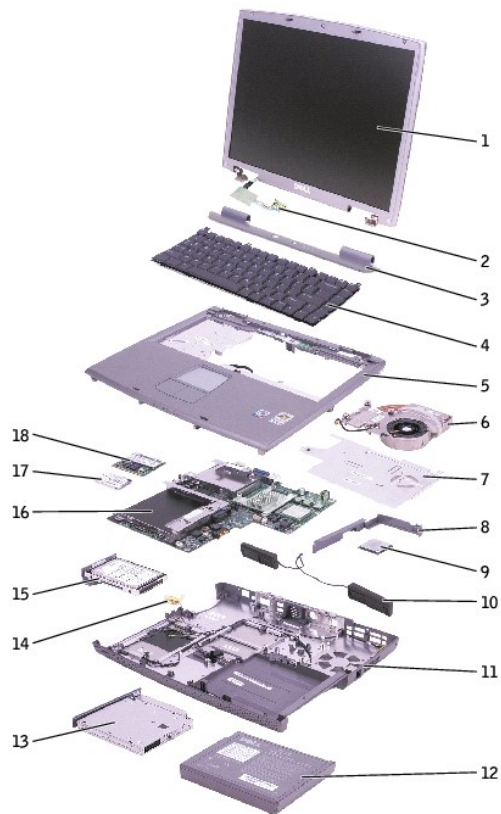

1	display	10	speakers
2	display-feed flex cable	11	base plastics
3	hinge cover	12	battery
4	keyboard	13	CD or DVD drive
5	palm rest	14	left antenna
6	microprocessor thermal-cooling assembly	15	hard drive
7	EMI shield	16	system board
8	battery bay shield	17	modem
9	microprocessor	18	Mini PCI card

Microprocessor Thermal-Cooling Assembly

Dell™ Inspiron™ 1150 Service Manual

Removing the Microprocessor Thermal-Cooling Assembly

⚠ CAUTION: Before performing the following procedures, read the safety instructions in your *Owner's Manual*.

⚠ CAUTION: To prevent static damage to components inside your computer, discharge static electricity from your body before you touch any of your computer's electronic components. You can do so by touching an unpainted metal surface.

1. Follow the instructions in "[Before Working Inside Your Computer](#)."
2. Remove the [keyboard](#).
3. Remove the [EMI shield](#).
4. Disconnect the fan power cable from the system board.
5. Loosen in consecutive order the four captive screws, labeled "1" through "4," that secure the microprocessor thermal-cooling assembly to the system board.

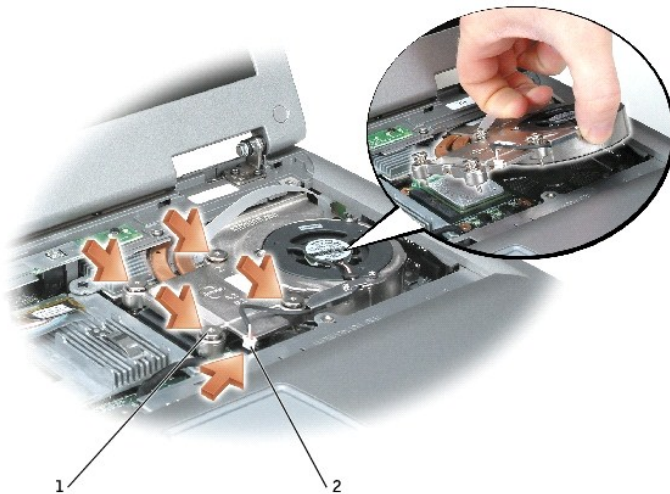

1	captive screws (4)
2	fan power-cable connector

6. Pull up the microprocessor thermal-cooling assembly by the pull-tab to lift the assembly out of the system board.

Installing the Microprocessor Thermal-Cooling Assembly

⚠ NOTICE: Before you install the replacement microprocessor thermal-cooling assembly, remove the mylar that covers the thermal grease on the assembly.

1. If you are installing a replacement microprocessor thermal-cooling assembly, remove the mylar that covers the thermal grease on the assembly. If you are installing the assembly that you removed in the previous section:
 - a. Wipe the thermal grease off of the microprocessor thermal-cooling assembly with a clean paper towel.
 - b. Squeeze all of the contents of the thermal grease packet (provided with the kit) on to the microprocessor thermal-cooling assembly.
2. Place the back of the microprocessor thermal-cooling assembly under the palm rest, and lower the assembly onto the system board.

3. Connect the fan power cable to the system board.
 4. Tighten the four captive screws, labeled "1" through "4," in consecutive order.
 5. Replace the [EMI shield](#).
 6. Replace the [keyboard](#).
-

[Back to Contents Page](#)

[Back to Contents Page](#)

Dell™ Inspiron™ 1150 Service Manual



NOTE: A NOTE indicates important information that helps you make better use of your computer.



NOTICE: A NOTICE indicates either potential damage to hardware or loss of data and tells you how to avoid the problem.



CAUTION: A CAUTION indicates a potential for property damage, personal injury, or death.

For a complete list of abbreviations and acronyms, see the *Tell Me How* help file.

If you purchased a Dell™ n Series computer, any references in this document to Microsoft® Windows® operating systems are not applicable.

Information in this document is subject to change without notice.
© 2004 Dell Inc. All rights reserved.

Reproduction in any manner whatsoever without the written permission of Dell Inc. is strictly forbidden.

Trademarks used in this text: *Dell*, the *DELL* logo, and *Inspiron* are trademarks of Dell Inc.; *Microsoft* and *Windows* are registered trademarks of Microsoft Corporation.

Other trademarks and trade names may be used in this document to refer to either the entities claiming the marks and names or their products. Dell Inc. disclaims any proprietary interest in trademarks and trade names other than its own.

Model PP08L

March 2004 Rev. A00

[Back to Contents Page](#)



Memory, CD or DVD Drive, Modem, and Mini PCI Card

Dell™ Inspiron™ 1150 Service Manual

- [Memory](#)
- [CD or DVD Drive](#)
- [Modem](#)
- [Mini PCI Card](#)

Memory

Removing the Memory Modules

-  **CAUTION:** Before working inside your Dell™ computer, read the safety instructions in your *Owner's Manual*.
-  **CAUTION:** To prevent static damage to components inside your computer, discharge static electricity from your body before you touch any of your computer's electronic components. You can do so by touching an unpainted metal surface.
-  **NOTE:** Memory modules purchased from Dell are covered under your computer warranty.
1. Follow the instructions in "[Before Working Inside Your Computer](#)."
 2. Turn the computer over, loosen the captive screw (labeled "M") in the memory module cover, and lift the cover away from the computer.

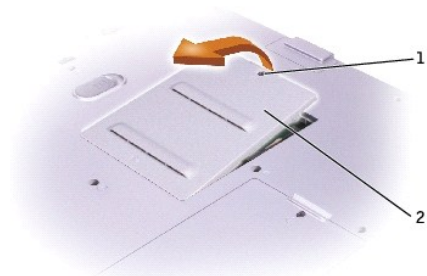

1	captive screw
2	memory module cover

3. Use your fingertips to carefully spread apart the securing clips on each end of the memory module connector until the module pops up.
4. Remove the module from the connector.

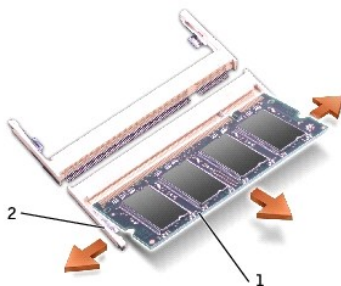

1	memory module
2	securing clips

Installing the Memory Modules

 **NOTE:** If the memory module is not installed properly, the computer may not boot properly. No error message indicates this failure.

1. Align the notch in the module edge connector with the tab in the connector slot.
2. Slide the module firmly into the slot at a 45-degree angle, and rotate the module down until it clicks into place. If you do not feel the click, remove the module and reinstall it.

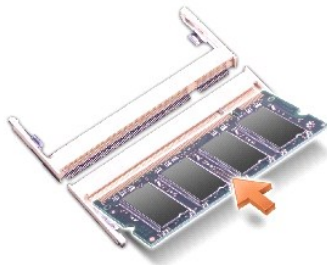

3. Replace the cover and tighten the captive screw.

 **NOTICE:** If the memory module cover is difficult to close, remove the module and reinstall it. Forcing the cover to close may damage your computer.

4. Insert the battery into the battery bay, or connect the AC adapter to your computer and an electrical outlet.
5. Turn on the computer.

As the computer boots, it detects the additional memory and automatically updates the system configuration information.

To confirm the amount of memory installed in the computer, click the **Start** button, click **Help and Support**, and then click **Computer Information**.

CD or DVD Drive

Removing the CD or DVD Drive

 **CAUTION:** Before working inside your Dell™ computer, read the safety instructions in your *Owner's Manual*.

 **CAUTION:** To prevent static damage to components inside your computer, discharge static electricity from your body before you touch any of your computer's electronic components. You can do so by touching an unpainted metal surface.

1. Follow the instructions in "[Before Working Inside Your Computer](#)."
2. Turn the computer over, and remove the M2.5 x 8-mm screw (labeled "O") next to the memory module cover.
3. Loosen the captive screw (labeled "M") in the memory module cover, and lift the cover away from the computer.

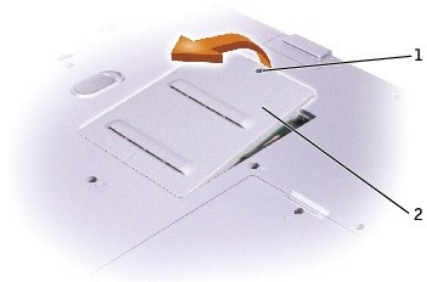

1	captive screw
2	memory module cover

- Press the lever next to the memory module connectors in the direction of the arrow on the lever (towards the drive) to release the drive.

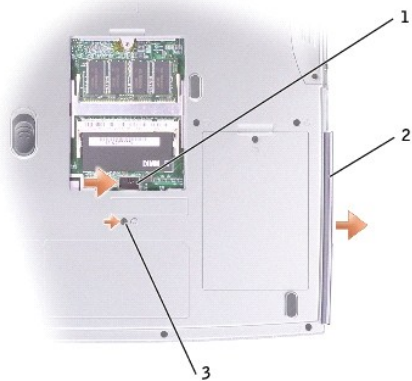

1	lever
2	CD or DVD drive
3	M2.5 x 8-mm screw labeled "O"

- Pull the drive out of the bay.

Installing the CD or DVD Drive

- Slide the new drive into the bay until the drive is fully seated.
- Replace the memory module cover and tighten the captive screw.
- Replace the M2.5 x 8-mm screw next to the memory module cover.

Modem

Removing the Modem

⚠ CAUTION: Before working inside your Dell™ computer, read the safety instructions in your *Owner's Manual*.

⚠ CAUTION: To prevent static damage to components inside your computer, discharge static electricity from your body before you touch any of your computer's electronic components. You can do so by touching an unpainted metal surface.

1. Follow the instructions in "[Before Working Inside Your Computer.](#)"
2. Turn the computer over, loosen the captive screw (labeled "C") in the modem/Mini PCI card cover, and lift the cover away from the computer.

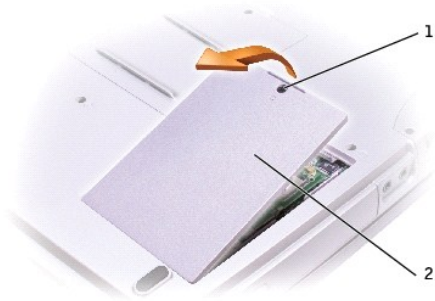

1	captive screw
2	modem/Mini PCI card cover

3. Remove the two M2 x 3-mm screws securing the modem to the system board, and set them aside.
4. Pull straight up on the attached pull-tab to lift the modem out of its connector on the system board and disconnect the modem cable.

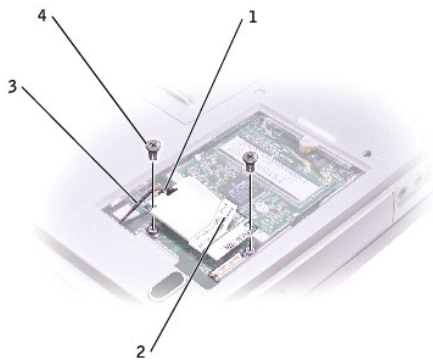

1	modem cable connector
2	pull-tab
3	modem cable
4	M2 x 3-mm screws (2)

Installing the Modem

1. Connect the modem cable to the modem.

➡ NOTICE: The cable connectors are keyed for correct insertion; do not force the connections.

2. Align the modem with the screw holes, and press the modem into the connector on the system board.
3. Install the two M2 x 3-mm screws to secure the modem to the system board.

4. Replace the cover and tighten the captive screw.

Mini PCI Card

Removing the Mini PCI Card

⚠ CAUTION: Before working inside your Dell™ computer, read the safety instructions in your *Owner's Manual*.

⚠ CAUTION: To prevent static damage to components inside your computer, discharge static electricity from your body before you touch any of your computer's electronic components. You can do so by touching an unpainted metal surface.

1. Follow the instructions in "[Before Working Inside Your Computer](#)."
2. Turn the computer over, loosen the captive screw (labeled "C") in the modem/Mini PCI card cover, and lift the cover away from the computer.

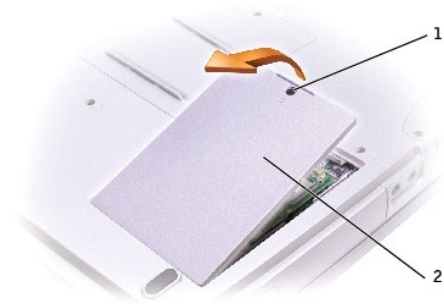

1	captive screw
2	modem/Mini PCI card cover

3. Disconnect the Mini PCI card from the attached cables.

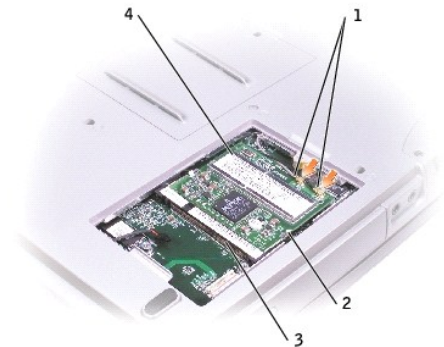

1	antenna cables
2	metal securing tabs (2)
3	Mini PCI card connector
4	Mini PCI card

4. Use your fingertips to carefully spread apart the securing taps on each end of the Mini PCI card connector until the card pops up.
5. Lift the Mini PCI card out of its connector.

Installing the Mini PCI Card

- ➔ **NOTICE:** To avoid damaging the Mini PCI card, never place cables on top of or under the card.
 - ➔ **NOTICE:** The connectors are keyed to ensure correct insertion. If you feel resistance, check the connectors and realign the card.
1. Align the Mini PCI card with the connector at a 45-degree angle, and press the Mini PCI card into the connector until it clicks.

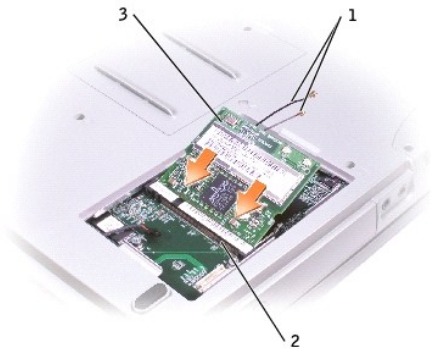

1	antenna cables
2	Mini PCI card connector
3	Mini PCI card

2. Connect the antenna cables to the Mini PCI card.

🔪 **NOTE:** To prevent damage to the antenna cables, carefully fold the cables under the Mini PCI card before replacing the cover.

3. Replace the cover and tighten the captive screw.

[Back to Contents Page](#)