

SECTION 7

AUDIO/VIDEO SYSTEM

Audio/video system

- Quick reference 186
- Using your audio/video system 189
 - Some basics 189
 - Radio operation 197
 - CD changer operation 208
 - DVD changer operation 222
 - Bluetooth® audio operation 247
 - USB memory/iPod operation 255
- Audio/video remote controls 263
- Audio/video system operating hints 265

Quick reference

Operations such as selecting a preset station and adjusting the sound balance are carried out on the screen. To display the audio screen, push the “MENU” button on the Remote Touch, then select “Audio”.

►DVD changer

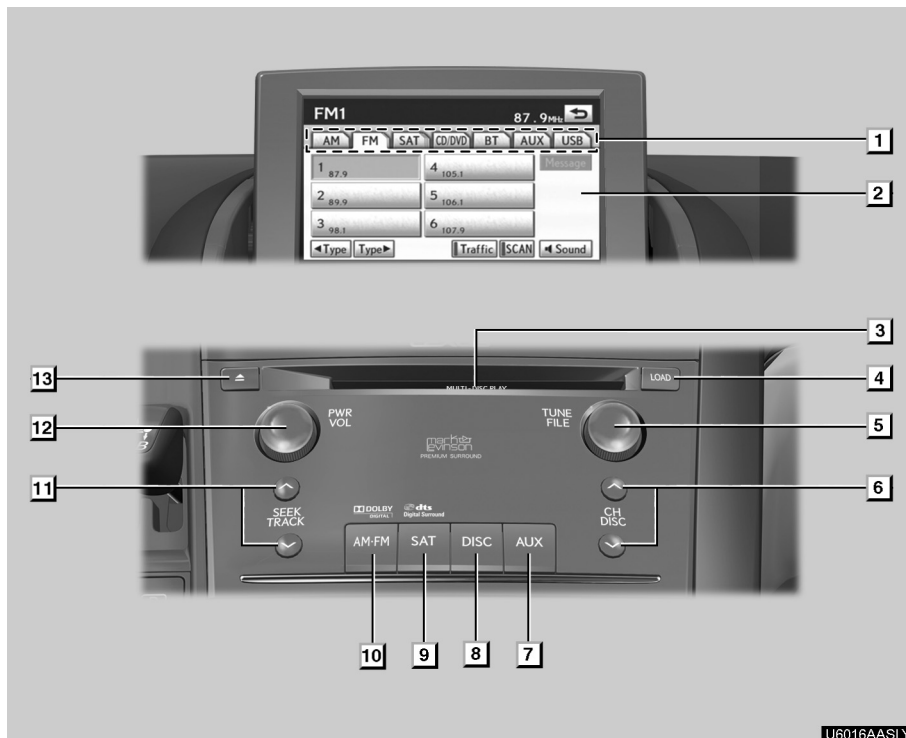

- 1** **Function menu tab**
To control the radio, DVD changer, Bluetooth® audio player, AUX, USB memory or iPod, select the screen tabs. For details, see page 191.
- 2** **Function menu display screen**
To control the radio, DVD changer, Bluetooth® audio player, AUX, USB memory or iPod, select the screen buttons. For details, see page 191.
- 3** **Disc slot**
Insert discs into the slot after pushing “LOAD” button. For details, see page 223.
- 4** **“LOAD” button**
Push this button to insert the discs. For details, see page 223.
- 5** **“TUNE/FILE” knob**
Turn this knob to move the station band and files up or down. For details, see pages 203, 218 and 259.

- 6** “**CH/DISC**” **button**
Push the “**^**” or “**∨**” button to select a preset station or a selected disc. For details, see pages 198, 204 and 225.
- 7** “**AUX**” **button**
Push this button to turn the Bluetooth® audio player, AUX, USB memory or iPod on. For details, see pages 191, 197, 247 and 255.
- 8** “**DISC**” **button**
Push this button to play a DVD. For details, see pages 191 and 222.
- 9** “**SAT**” **button**
Push this button to choose a SAT station. For details, see pages 191 and 202.
- 10** “**AM-FM**” **button**
Push this button to choose a radio station. (AM, FM1, FM2)
For details, see pages 191 and 197.
- 11** “**SEEK/TRACK**” **button**
Push the “**^**” or “**∨**” button to seek up or down for a station, or to access a desired track, file or chapter. For details, see pages 199, 204, 214, 218, 234, 244, 253 and 259.
- 12** “**PWR/VOL**” **knob**
Push this knob to turn the audio system on and off, and turn it to adjust the volume. For details, see page 191.
- 13** “**▲**” **button**
Push this button to eject the discs. For details, see page 225.

AUDIO/VIDEO SYSTEM

► CD changer

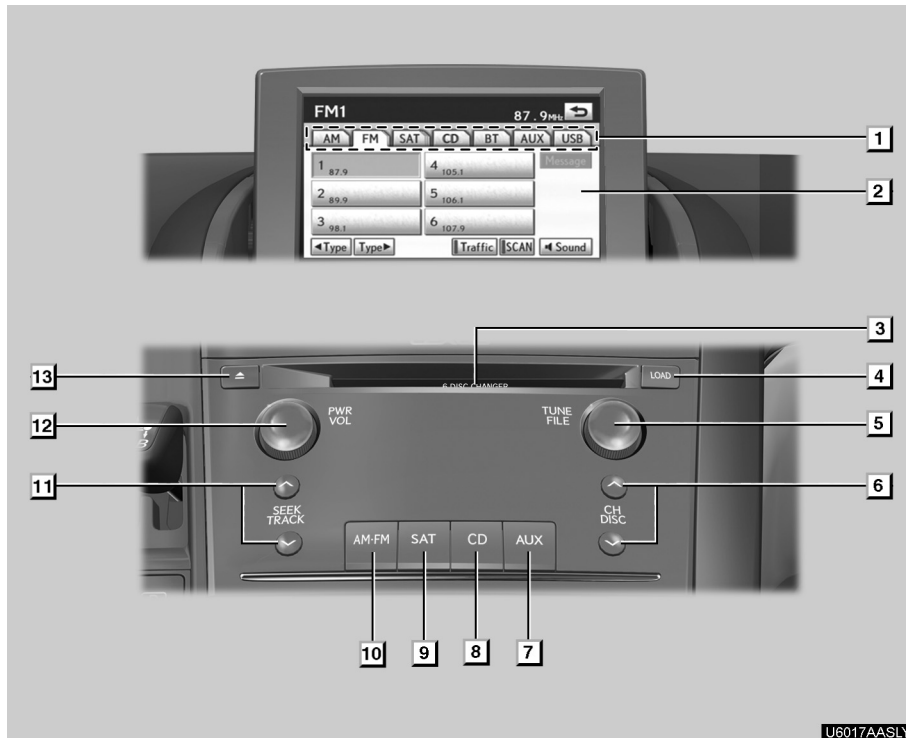

- 1** **Function menu tab**
To control the radio, CD changer, Bluetooth® audio player, AUX, USB memory or iPod, select the screen tabs. For details, see page 191.
- 2** **Function menu display screen**
To control the radio, CD changer, Bluetooth® audio player, AUX, USB memory or iPod, select the screen buttons. For details, see page 191.
- 3** **Disc slot**
Insert discs into the slot after pushing “LOAD” button. For details, see page 208.
- 4** **“LOAD” button**
Push this button to insert the discs. For details, see page 208.
- 5** **“TUNE/FILE” knob**
Turn this knob to move the station band and files up or down. For details, see pages 203, 218 and 259.
- 6** **“CH/DISC” button**
Push the “^” or “v” button to select a preset station or a selected disc. For details, see pages 198, 204 and 210.
- 7** **“AUX” button**
Push this button to turn the Bluetooth® audio player, AUX, USB memory or iPod on. For details, see pages 191, 197, 247 and 255.
- 8** **“CD” button**
Push this button to play a CD. For details, see pages 191 and 208.

Using your audio/video system — — Some basics

- 9** **“SAT” button***
Push this button to choose a SAT station. For details, see pages 191 and 202.
- 10** **“AM-FM” button**
Push this button to choose a radio station. (AM, FM1, FM2)
For details, see pages 191 and 197.
- 11** **“SEEK/TRACK” button**
Push the “^” or “v” button to seek up or down for a station, or to access a desired track, file or chapter. For details, see pages 199, 204, 214, 218, 253 and 259.
- 12** **“PWR/VOL” knob**
Push this knob to turn the audio system on and off, and turn it to adjust the volume. For details, see page 191.
- 13** **“▲” button**
Push this button to eject the discs. For details, see page 210.

*: with XM® Satellite Radio broadcast

This section describes some of the basic features of your audio/video system. Some information may not pertain to your system.

Your audio/video system works when the “POWER” switch is turned to ACCESSORY or ON mode.

FCC ID : AJDK021
IC : 775E-K021

This device complies with Part 15 of the FCC Rules and RSS-Gen and RSS-210 of IC Rules. Operation is subject to the following two conditions : (1) This device may not cause harmful interference, and (2) this device must accept any interference received, including interference that may cause undesired operation.



CAUTION

FCC WARNING: Changes or modifications not expressly approved by the party responsible for compliance could void the user's authority to operate the equipment.

CAUTION: Radio Frequency Radiation Exposure

This equipment complies with FCC radiation exposure limits set forth for uncontrolled equipment and meets the FCC radio frequency (RF) Exposure Guidelines in Supplement C to OET65. This equipment has very low levels of RF energy that it deemed to comply without maximum permissive exposure evaluation (MPE). But it is desirable that it should be installed and operated with at least 20 cm and more between the radiator and person's body (excluding extremities: hands, wrists, feet and ankles).

Co-location: This transmitter must not be co-located or operated in conjunction with any other antenna or transmitter.

● **Laser products**

- Do not take this unit apart or attempt to make any changes yourself. This is an intricate unit that uses a laser pickup to retrieve information from the surface of compact discs. The laser is carefully shielded so that its rays remain inside the cabinet. Therefore, never try to disassemble the player or alter any of its parts since you may be exposed to laser rays and dangerous voltages.
- This product utilizes a laser. Use of controls or adjustments or performance of procedures other than those specified herein may result in hazardous radiation exposure.

NOTICE

To prevent the 12-volt battery from being discharged, do not leave the audio/video system on longer than necessary when the hybrid system is off.

(a) Voice command system



By pushing the switch above, you can operate the voice command system.

For the operation of the voice command system and the list of commands, see pages 51 and 55.

(b) Turning the system on and off



“PWR/VOL”: Push this knob to turn the audio system on and off. Turn this knob to adjust the volume. The system turns on in the last mode used.

You can select the function that enables automatic return to the previous screen from the audio screen. See page 312 for details.

(c) Switching between functions

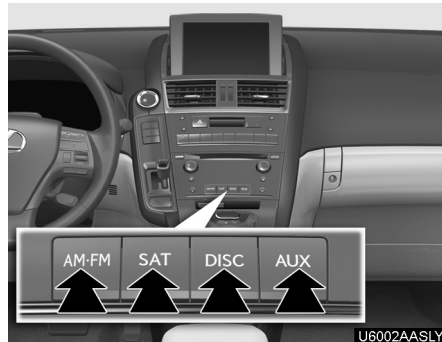

► DVD changer image

Push the **“AM-FM”**, **“SAT”**, **“DISC”**, **“CD”** or **“AUX”** button to turn on the desired mode.

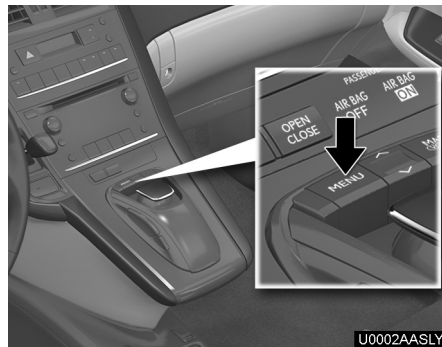

1. Push the **“MENU”** button on the Remote Touch.

Start



2. Select **“Audio”**.

AUDIO/VIDEO SYSTEM

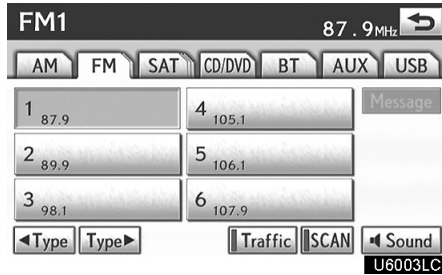

3. Select "AM", "FM", "SAT", "CD", "CD/DVD", "BT", "AUX" or "USB" tab to turn on the desired mode.

Push these buttons or tabs if you want to switch from one mode to another.

If the disc is not set, the CD changer/DVD changer does not turn on.

You can turn off the CD changer/DVD changer by ejecting all the discs. If the audio system was previously off, then the entire audio system will be turned off when you eject all the discs.

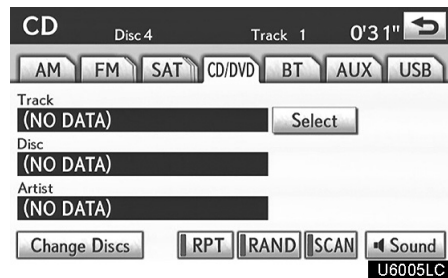
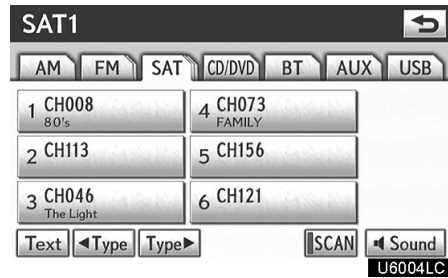
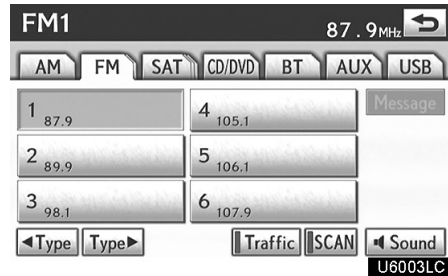

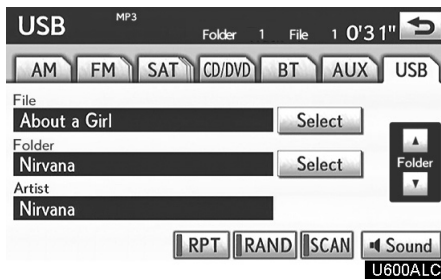
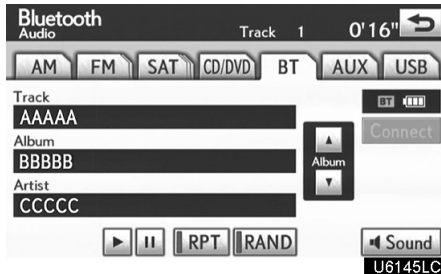
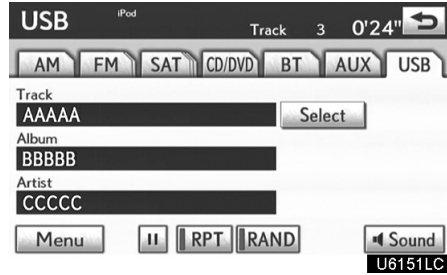
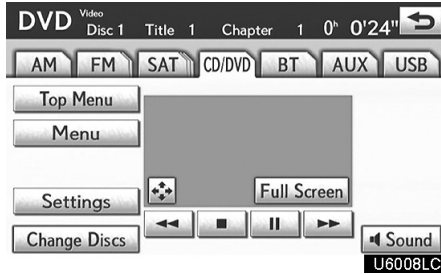

The screen buttons for radio, CD changer, DVD changer, Bluetooth® audio player, AUX, USB memory and iPod operation are displayed on the screen when the audio control mode is selected.

Select the tab to select the desired mode when the audio control mode is selected.

INFORMATION

You cannot operate dimmed screen buttons.

(d) DSP control

1. Push the “MENU” button on the Remote touch, then select “Audio”.

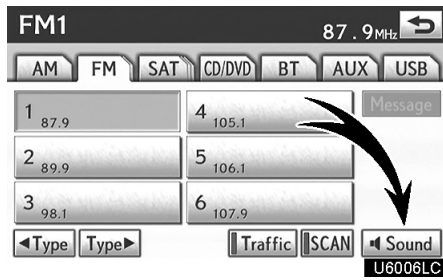

2. Select “Sound” to display the sound adjustment screen.

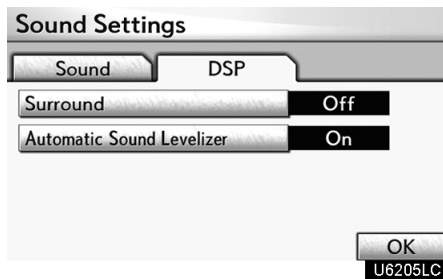

3. Select “DSP” tab to display this screen.

4. Select the desired button.

Surround function (if equipped):
Select “On” of “Surround” and select “OK”.

The surround function will turn on.

Automatic sound levelizer (ASL) (if equipped):

When the audio sound becomes difficult to hear due to road noise, wind noise or other noises while driving, select “On”. The system adjusts to the optimum volume and tone quality according to the speed of car, wind noise or other noise.

(e) Tone and balance

Tone

How good an audio program sounds to you is largely determined by the mix of the treble, mid and bass levels. In fact, different kinds of music and vocal programs usually sound better with different mixes of treble, mid and bass.

Balance

A good balance of the left and right stereo channels and of the front and rear sound levels is also important.

Keep in mind that if you are listening to a stereo recording or broadcast, changing the right/left balance will increase the volume of one group of sounds while decreasing the volume of another.

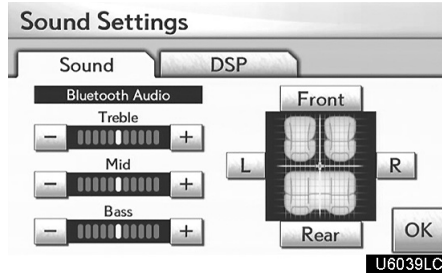

1. Select “Sound” tab to display this screen.

2. Select the desired button.

“Treble” “+” or “-”: Adjust high-pitched tones.

“Mid” “+” or “-”: Adjust mid-pitched tones.

“Bass” “+” or “-”: Adjusts low-pitched tones.

“Front” or “Rear”: Adjusts sound balance between the front and rear speakers.

“L” or “R”: Adjusts sound balance between the left and right speakers.

3. Select “OK”.

The tone of each mode (for such as AM, FM, CD changer and DVD changer) can be adjusted.

(f) Selecting screen size (DVD changer only)

Before selecting screen size, it is necessary to insert a DVD disc and select DVD mode.

1. Push the “MENU” button on the Remote Touch, then select “Audio”.

2. Select “CD/DVD” tab.



3. Select “Settings”.



4. Select “Wide”.

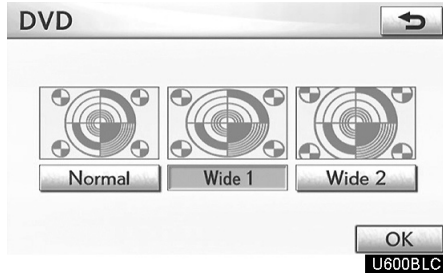

5. Select the desired button.

- “Normal”: Displays a 3 : 4 screen, with either side in black.
- “Wide 1”: Widens the 3 : 4 screen horizontally to fill the screen.
- “Wide 2”: Widens the 3 : 4 screen vertically and horizontally, in the same ratio, to fill the screen.

When you select , the previous screen returns.

6. Select “OK”.

(g) Your CD or DVD changer

When you insert a disc, push the “LOAD” button and gently push the disc in with the label side up. This CD or DVD changer can store up to six discs.

The changer is intended for use with 4.7 in. (12 cm) discs only.

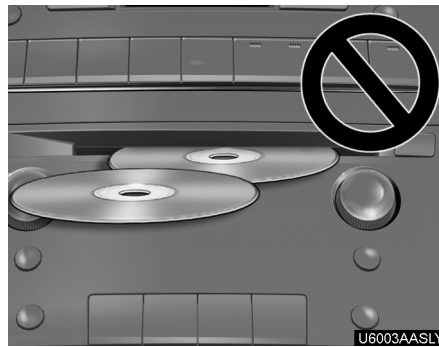

NOTICE

- ***Do not stack up two discs for insertion, or it will cause damage to the changer. Insert only one disc into the slot at a time.***
- ***Never try to disassemble or oil any part of the changer. Do not insert anything other than a disc into the slot.***

(h) AUX port

The sound of portable audio players connected to the AUX port can be enjoyed. Push the **"AUX"** button to display audio screen and select **"AUX"** tab to switch to AUX mode. When the portable audio player is not connected to the AUX port, the tab will tone down. For details, refer to the "Owner's Manual".

(i) USB port

It is available to connect a USB memory/iPod device with the USB port. When the USB memory/iPod is not connected to the USB port, the tab will tone down. For details, see "(a) Connecting a USB memory or iPod" on page 256.

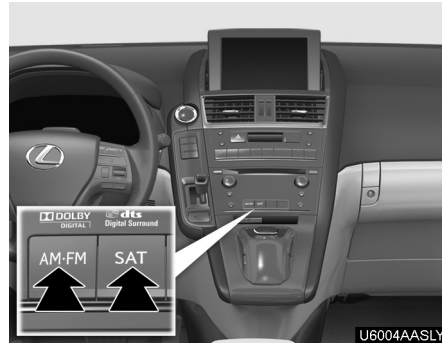
— Radio operation**(a) Listening to the radio**

Push the "AM-FM" button to display audio screen and select "AM" or "FM" tabs to choose either an AM or FM station.

"AM", "FM1" or "FM2" appears on the screen.

If your vehicle is equipped with a satellite radio broadcast system, when you push the **"SAT"** button or select **"SAT"** tab on audio screen, "SAT1", "SAT2", "SAT3" station appears on the display. For details about satellite radio broadcast, see "—Radio operation (XM® Satellite Radio broadcast)" on page 202.



Turn the knob clockwise to step up the station band or counterclockwise to step down.

Your radio automatically changes to stereo reception when a stereo broadcast is received. "ST" appears on the screen. If the signal becomes weak, the radio reduces the amount of channel separation to prevent the weak signal from creating noise. If the signal becomes extremely weak, the radio switches from stereo to mono reception. In this case, "ST" disappears from the screen.

(b) Presetting a station

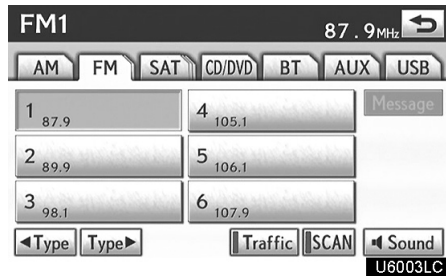

1. Tune in the desired station.
2. Select one of the buttons (1 — 6) you want and hold it until a beep is heard. This sets the station to the button and the frequency appears on the button.

Each radio mode (AM, FM1 or FM2) can store up to 6 stations. To change the preset station to a different one, follow the same procedure.

The preset station memory is cancelled when the power source is interrupted by 12-volt battery disconnection or a blown fuse.

(c) Selecting a station

Tune in the desired station using one of the following methods.

Preset tuning: Select the button (1 — 6) for the station you want. The button is highlighted and the station frequency appears on the screen.

Seek tuning: Push the “^” or “v” of the “SEEK/TRACK” button. The radio will begin seeking up or down for a station of the nearest frequency and will stop on reception. Each time you push the button, the stations will be searched automatically one after another.

To scan all the frequencies: Select “SCAN” on the screen briefly. “SCAN” appears on the screen. The radio will find the next station and stay there for a few seconds, and then scan again. To select a station, select “SCAN” again.

To scan the preset stations: Select “SCAN” on the screen for longer than a second. “P. SCAN” appears on the screen. The radio will tune in the next preset station, stay there for a few seconds, and then move to the next preset station. To select a station, select “SCAN” again.

(d) Radio Data System

Your audio system is equipped with Radio Data Systems (RDS). RDS mode provides you to receive text messages from radio stations that utilize RDS transmitters.

When RDS is on, the radio can

- only select stations of a particular program type,
- display messages from radio stations,
- search for a stronger signal station.

RDS features are available for use only on FM stations which broadcast RDS information.

AUDIO/VIDEO SYSTEM

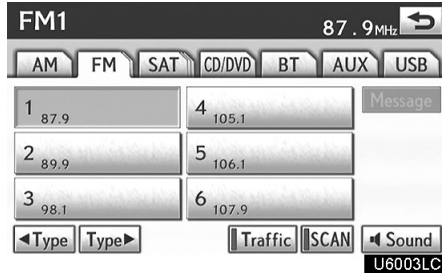

“Type ◀▶”

If the system receives no RDS stations, “NO-PTY” appears on the display.

Each time you select “◀ Type ” or “Type ▶”, the program type changes as in the following:

- ROCK
- MISC (Miscellaneous)
- INFORM (Information)
- EASY LIS (Easy listening)
- CLS/JAZZ (Classical music and Jazz)
- R & B (Rhythm and Blues)
- RELIGION
- ALART (Emergency message)

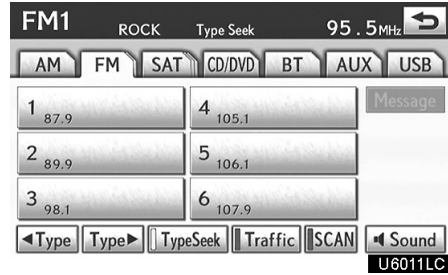

“TypeSeek”

When a program is set, “Type Seek” appears. Select the button and the system starts to seek the station in the relevant program type.

If any type program station is not found, “Nothing” appears on the display.

“Message”

If the system receives a radio text from RDS station, “MSG” appears on the display. Select **“Message”**, and a text message is displayed on the screen. This function is available only when the vehicle is not moving.

When you select **“Message Off”**, the display returns.

(e) Traffic announcement

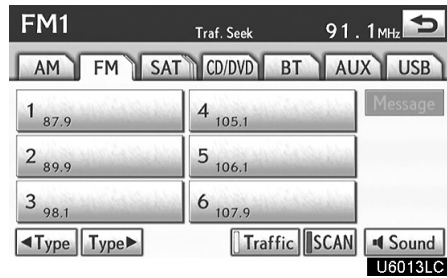

“Traffic”

A station that regularly broadcasts traffic information is automatically located.

When you select **“Traffic”**, “Traf. Seek” appears on the display and the radio will start seeking any traffic program station.

If no traffic program station is found, “Nothing” appears on the display.

If a traffic program station is found, the name for traffic program station is displayed for a while until a traffic announcement is received.

AUDIO/VIDEO SYSTEM

—Radio operation (XM[®] Satellite Radio broadcast) (if equipped)

To listen to a satellite radio broadcast in your vehicle, a subscription to the XM[®] Satellite Radio service is necessary.

(a) How to subscribe to an XM[®] Satellite Radio

An XM[®] Satellite Radio is a tuner designed exclusively to receive broadcasts provided under a separate subscription. Availability is limited to the 48 contiguous U.S. states and some Canadian provinces.

How to subscribe:

You must enter into a separate service agreement with the XM[®] Satellite Radio in order to receive satellite broadcast programming in the vehicle. Additional activation and service subscription fees apply that are not included in the purchase price of the vehicle and optional digital satellite tuner.

For complete information on subscription rates and terms, or to subscribe to the XM[®] Satellite Radio.

U.S.A.—

Visit on the web at www.xmradio.com or call 1-877-515-3987.

Canada—

Visit on the web at www.xmradio.ca or call 1-877-515-3987.

The XM[®] Satellite Radio is solely responsible for the quality, availability and content of the satellite radio services provided, which are subject to the terms and conditions of the XM[®] Satellite Radio customer service agreement.

Customers should have their radio ID ready; the radio ID can be found by tuning to “channel 000” on the radio. For details, see “(b) Displaying the radio ID” below.

All fees and programming are the responsibility of the XM[®] Satellite Radio and are subject to change.

Satellite tuner technology notice:

Lexus’s satellite radio tuners are awarded Type Approval Certificates from XM[®] Satellite Radio Inc. as proof of compatibility with the services offered by the XM[®] Satellite Radio.

(b) Displaying the radio ID

Each XM[®] tuner is identified with a unique radio ID. You will need the radio ID when activating XM[®] service or when reporting a problem.

If you select the “CH 000” using the “TUNE/FILE” knob, the ID code of 8 alphanumeric characters appears. If you select another channel, display of the ID code is canceled. The channel(000) alternates the display between the radio ID and the specific radio ID code.

(c) Listening to satellite radio

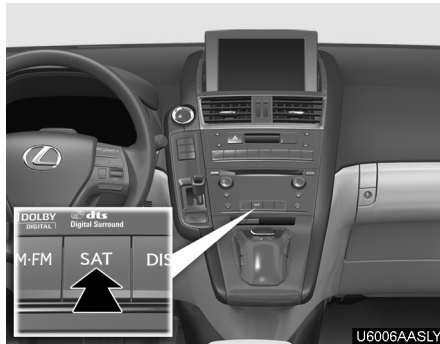

Push the “SAT” button to display audio screen and select “SAT” tab to choose a SAT channel.

“SAT1”, “SAT2” or “SAT3” appears on the screen.



Turn this knob to select the next or previous channel.

If you turn continuously, you can rapidly scroll forward or down through the channels.

(d) Channel category

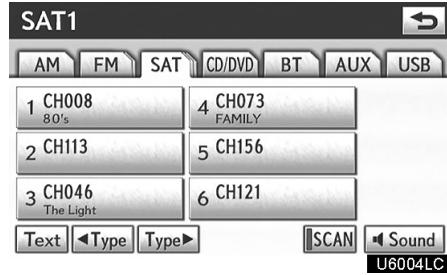

Select either “<Type” or “Type>” to go to the next or previous category.

(e) Presetting a channel

1. Tune in the desired channel.

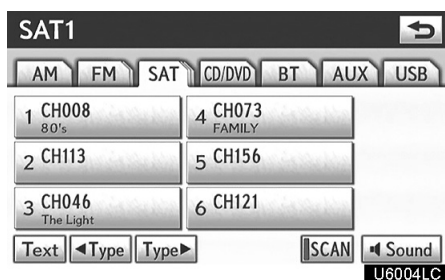

2. Select one of the channel selector buttons (1 — 6) and hold it until a beep is heard.

This sets the channels to the button and the name and number of the channel appears on the button.

Each button can store three SAT channels. To change the preset channel to a different one, follow the same procedure.

The preset channel memory is cancelled when the power source is interrupted by 12-volt battery disconnection or a blown fuse.

(f) Selecting a channel

Tune in the desired channel using one of the following methods.

Preset tuning: Select the channel selector button (1 — 6) for the channel you want. The button (1 — 6) is highlighted and channel number appears on the display.

To select channel within the current category: Push the “^” or “v” button of the “SEEK/TRACK”. The radio will step up or down the channel within the current channel category.

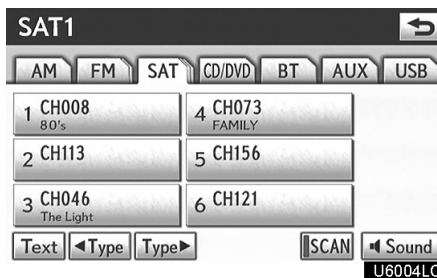

To scan the currently selected channel category: Select “SCAN” briefly. “SCAN” appears on the display. The radio will find the next channel in the same channel category, stay there for a few seconds, and then scan again. To select a channel, select “SCAN” a second time.

To scan the preset channels: Select “SCAN” and hold it until you hear a beep. “P.SCAN” appears on the display. The radio will find the next preset channel, stay there for a few seconds, and then move to the next preset channel. To select a channel, select “SCAN” a second time.

(g) Displaying the title and name

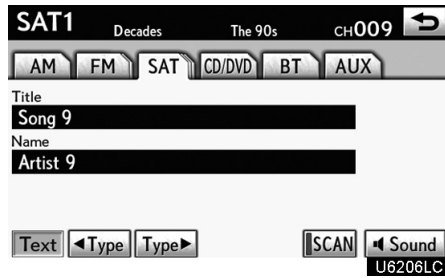

When you select “**Text**”, the song/program title and the artist name/feature are displayed.

Up to 16 alphanumeric characters can be displayed. (Some information will not be fully displayed.)

When you select “**Text**” again, the display returns.

AUDIO/VIDEO SYSTEM

(h) If the satellite radio tuner malfunctions

When problems occur with the XM® tuner, a message will appear on the display. Referring to the table below to identify the problem, take the suggested corrective action.

ANTENNA	The XM® antenna is not connected. Check whether the XM® antenna cable is attached securely.
	A short circuit occurs in the antenna or the surrounding antenna cable. See a Lexus certified dealer for assistance.
UNAUTH	You have not subscribed to the XM® Satellite Radio. The radio is being updated with the latest encryption code. Contact the XM® Satellite Radio for subscription information. When a contract is canceled, you can choose the "CH000" and all free-to-air channels.
	The premium channel you selected is not authorized. Wait for about 2 seconds until the radio returns to the previous channel or "CH001". If it does not change automatically, select another channel. If you want to listen to the premium channel, contact the XM® Satellite Radio.
NO SIGNAL	The XM® signal is too weak at the current location. Wait until your vehicle reaches a location with a stronger signal.
LOADING	The unit is acquiring audio or program information. Wait until the unit has received the information.
OFF AIR	The channel you selected is not broadcasting any programming. Select another channel.
-----	There is no song/program title or artist name/feature associated with the channel at that time. No action needed.
CHUNAVL	The channel you selected is no longer available. Wait for about 2 seconds until the radio returns to the previous channel or "CH001". If it does not change automatically, select another channel.

Contact the XM® Listener Care Center at 1-877-515-3987.

NOTICE

This equipment has been tested and found to comply with the limits for a class B digital device, pursuant to Part 15 of the FCC Rules. These limits are designed to provide reasonable protection against harmful interference in a residential installation. This equipment generates, uses and can radiate radio frequency energy and, if not installed and used in accordance with the instructions, may cause harmful interference to radio communications. However, there is no guarantee that interference will not occur in a particular installation.

If this equipment does cause harmful interference to radio or television reception, which can be determined by turning the equipment off and on, the user is encouraged to try to correct the interference by one or more of the following measures:

- Reorient or relocate the receiving antenna.*
- Increase the separation between the equipment and receiver.*
- Connect the equipment into an outlet on a circuit different from that to which the receiver is connected.*
- Consult the dealer or an experienced radio/TV technician for help.*

Information to user

Alternation or modifications carried out without appropriate authorization may invalidate the user's right to operate the equipment.

INFORMATION

This XM[®] tuner supports "Audio Services" (Music and Talk) of only XM[®] Satellite Radio and "Text Information" linked to the respective "Audio Services".

**:Text Information includes, Station Name, (Artist) Name, (Song) Title and Category Name.*

— CD changer operation

(a) Inserting discs

The “POWER” switch must be in ACCESSORY or ON mode.

Your CD changer can store up to 6 discs.

You can set a disc at the lowest empty disc number.

● Setting a single disc:



1. Push the “LOAD” button briefly.

The amber indicators at both ends of the slot start blinking. After the amber indicators change to green and stay on, the CD changer door will open.

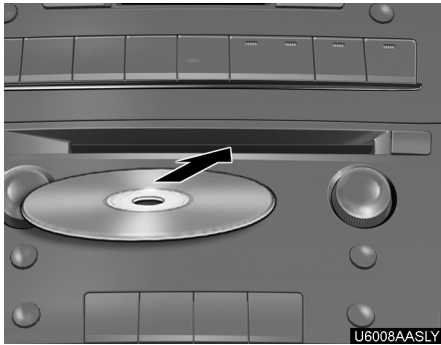

2. Insert only one disc while the CD changer door is open.

You can set a disc at the lowest empty disc number.

After insertion, the set disc is automatically loaded.

If the label faces down, the disc cannot be played. In this case, "Check CD ×" appears on the screen.

If you do not insert the disc within 15 seconds after pushing the "LOAD" button, a beep will sound and the operation will be canceled automatically.

If you need to insert the next disc, repeat the same procedure to insert another disc.

● **Setting all the discs:**



1. Push the "LOAD" button until you hear a beep.

The amber indicators at both ends of the slot start blinking. After the amber indicators change to green and stay on, the CD changer door will open.

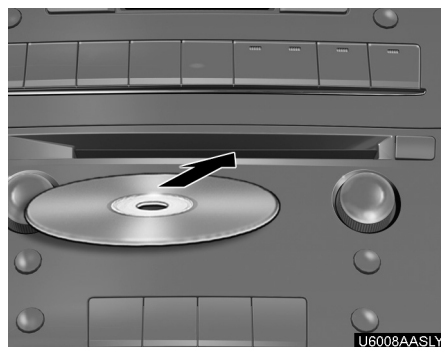

2. Insert only one disc while the CD changer door is open.

The CD changer door closes and the amber indicators start blinking.

3. Insert the next disc after the amber indicators change to green and stay on and the CD changer door opens.

4. Repeat this procedure until you insert all the discs.

To cancel the operation, push the “LOAD” button briefly.

If you do not insert the discs within 15 seconds after pushing the “LOAD” button, the beep will sound and the operation will be canceled automatically.

NOTICE

Do not insert one disc stacked on top of another one or feed them in continuously, to prevent discs from getting stuck in the changer.

(b) Ejecting discs

- A single disc alone:

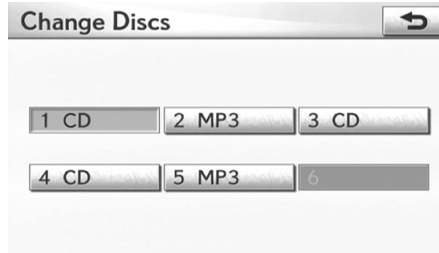

U6122LC



U6009AASLY

1. Push the “^” or “v” button of the “CH/DISC” or select the disc number button on the “Change Discs” screen to highlight the disc number you want to eject.

To display the “Change Discs” screen, select “Change Discs” on each audio control screen.



2. Push the “▲” button for the disc briefly.

At this time, the amber indicators of the slot start blinking and the disc is ejected.

3. After the blinking indicators stay on, remove the disc.

● **Ejecting all the discs:**



1. Push the “▲” button for the disc until you hear a beep.

At this time, the amber indicators of the slot start blinking and a disc is ejected.

2. After the blinking indicators stay on, remove the disc.

The indicators start blinking again and the next disc is ejected.

If you do not remove the disc within 15 seconds after it is ejected, the beep will sound and the operation will be canceled automatically.

When all the discs are removed, the indicators go out.

AUDIO/VIDEO SYSTEM

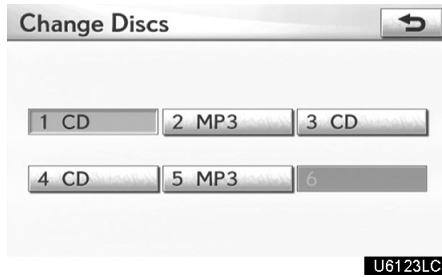

The numbers of the trays where the disc is not set are dimmed.

(c) Playing a disc

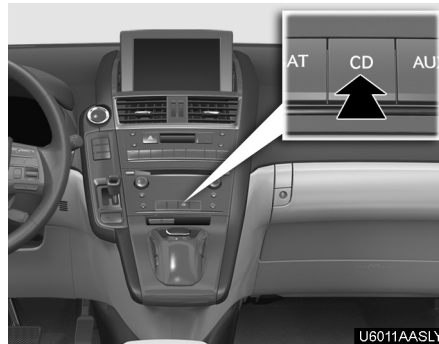

Push the “CD” button to display audio screen and select “CD” tab if the discs are already loaded in the changer.

The discs set in the changer are played continuously, starting with the last disc you inserted. The disc number of the disc currently being played, the track number and the time from the beginning of the program appear on the screen.

When play of one disc ends, the first track of the following disc starts. When play of the final disc ends, play of the first disc starts again.

The changer will skip any empty disc trays.

(d) Selecting a desired disc

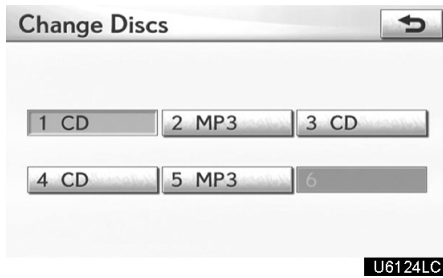

On the screen:

Select “CD” tab and select “Change Discs”

The selected disc number is highlighted.
The changer will start playing the selected disc from the first track.

On the audio panel:

Push the “^” or “v” button of the “CH/DISC”.

When you release the button, the changer will start playing the selected disc from the first track.

(e) Playing an audio disc

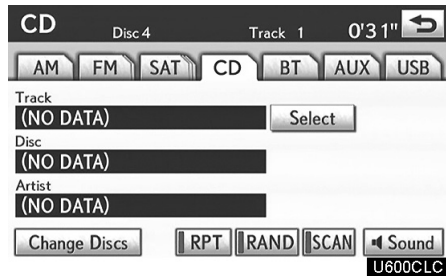

Select “CD” tab, then select “Change Discs”. Choose an audio disc number to display this screen.

SELECTING A DESIRED TRACK



“SEEK/TRACK” button: Use for direct access to a desired track.

Push the “^” or “v” button of the **“SEEK/TRACK”** button and repeat it until the desired track number appears on the screen. As you release the button, the changer will start playing the selected track from the beginning.

“Select” for Track: The desired track can be selected from a list. This function is available only when the vehicle is not moving.

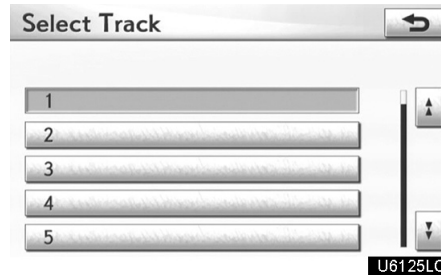

Select **“Select”**. The track list is displayed.





Select the desired track number. The changer will start playing the selected track from the beginning.

 : By selecting this button, the list moves up by 5 track groups. If this button is selected when the top page of the list is displayed, the last page is displayed.

 : By selecting this button, the list moves down by 5 track groups. If this button is selected when the last page of the list is displayed, the top page is displayed.

 ,  : If  appears to the right of the item name, the complete name is too long for the display.

Select  to scroll to the end of the name. Select  to scroll the beginning of the name.

Fast forward: Push the “^” button of the **“SEEK/TRACK”** button and hold it to fast forward the disc. When you release the button, the changer will resume playing from that position.

Reverse: Push the “v” button of the **“SEEK/TRACK”** button and hold it to reverse the disc. When you release the button, the changer will resume playing.

SEARCHING FOR A DESIRED TRACK OR DISC

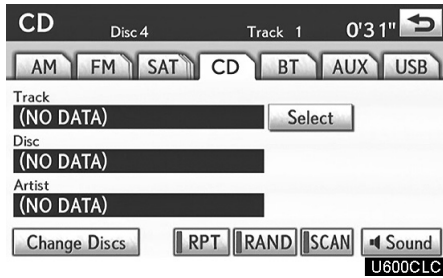

Searching for a desired track —

Select “SCAN” on the screen briefly while the disc is playing.

“SCAN” appears on the screen. The changer will play the next track for 10 seconds, then scan again. To select a track, select “SCAN” on the screen a second time. If the changer reaches the end of the disc, it will continue scanning at track 1.

After all the tracks are scanned in one pass, normal play resumes.

Searching for a desired disc —

Select “SCAN” on the screen for longer than a second while the disc is playing.

“D.SCAN” appears on the screen. The program at the beginning of each audio disc will be played for 10 seconds. To continue listening to the program of your choice, select “SCAN” on the screen a second time.

After all the audio discs are scanned in one pass, normal play resumes.

OTHER FUNCTIONS

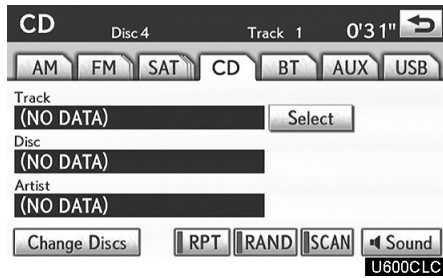

“RPT”: Use it for automatic repeat of the track or disc you are currently listening to.

Repeating a track —

Select **“RPT”** briefly while the track is playing. **“RPT”** appears on the screen. When the track is finished, the changer will automatically go back to the beginning of the track and play the track again. To cancel it, select **“RPT”** once again.

Repeating a disc —

Select **“RPT”** for longer than a second while the disc is playing. **“D.RPT”** appears on the screen. When the disc is finished, the changer will automatically go back to the beginning of the disc and play the disc again. To cancel it, select **“RPT”** once again.

“RAND”: Use it for automatic and random selection.

Playing the tracks on one disc in random order —

Select **“RAND”** briefly while the disc is playing. **“RAND”** appears on the screen. The system selects a track on the disc being listened to in random order. To cancel it, select **“RAND”** once again.

Playing the tracks on all the audio discs in random order —

Select **“RAND”** for longer than a second while the disc is playing. **“D.RAND”** appears on the screen. The system selects a track on all the audio discs in the changer in random order. To cancel it, select **“RAND”** once again.

If a CD-TEXT disc is inserted, the title of the disc and track will be displayed. Up to 32 letters can be displayed.

(f) Playing a MP3/WMA disc

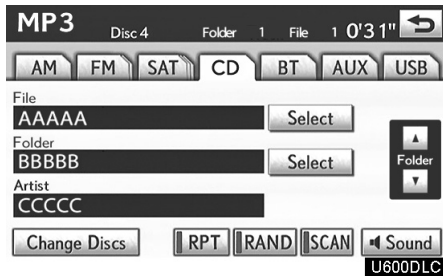

Select “CD” tab, then select “Change Discs”. Choose an MP3/WMA disc number to display this screen.

SELECTING A DESIRED FOLDER

“Folder▲” : Select this button to go to the next folder.

“Folder▼” : Select this button to go to the previous folder.

“Select” for Folder: The desired folder can be selected in a list. This function is available only when the vehicle is not moving.

Select “Select”. The folder list is displayed.

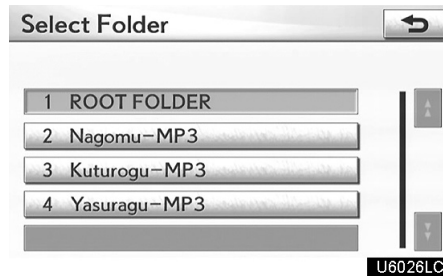

Select the desired folder number. The changer will start playing the first file of the selected folder.

▲ : By selecting this button, the list moves up by 5 folder groups. If this button is selected when the top page of the list is displayed, the last page is displayed.

▼ : By selecting this button, the list moves down by 5 folder groups. If this button is selected when the last page of the list is displayed, the top page is displayed.

SELECTING A DESIRED FILE



“SEEK/TRACK” button: Use for direct access to a desired file.

Push the “^” or “v” button of the **“SEEK/TRACK”** button and repeat it until the desired file number appears on the display. As you release the button, the changer will start playing the selected file from the beginning. When “RAND” or “FLD.RPT” is on, the file number within the folder you are currently listening to appears.

Fast forward: Push the “^” button of the **“SEEK/TRACK”** button and hold it to fast forward the disc. When you release the button, the changer will resume playing from that position.

Reverse: Push the “v” button of the **“SEEK/TRACK”** button and hold it to reverse the disc. When you release the button, the changer will resume playing.



“TUNE/FILE” knob: Use for direct access to a desired file in the disc.

Turn the **“TUNE/FILE”** knob to step up or down all the files in the disc you are currently listening to. The file number appears on the display. When “RAND” or “FLD.RPT” is on, all the files in the folder you are currently listening to can be stepped up or down.

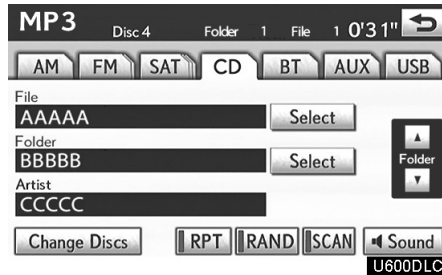

“Select” for File: The desired file can be selected in a list. This function is available only when the vehicle is not moving. Select **“Select”**. The file list is displayed.

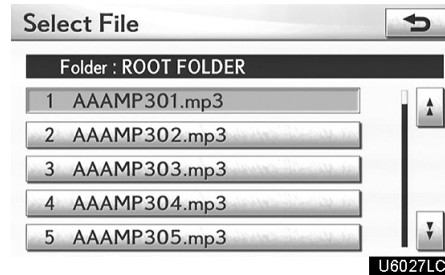

Select the desired file number. The changer will start playing the selected file from the beginning.

 : By selecting this button, the list moves up by 5 file groups. If this button is selected when the top page of the list is displayed, the last page is displayed.

 : By selecting this button, the list moves down by 5 file groups. If this button is selected when the last page of the list is displayed, the top page is displayed.

SEARCHING FOR A DESIRED FILE

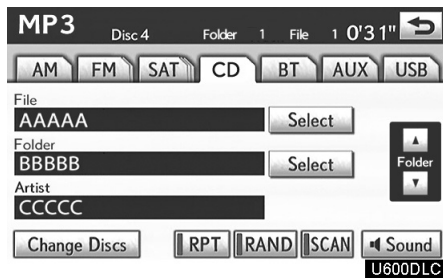

Select **“SCAN”** on the screen briefly while the disc is playing.

“SCAN” appears on the screen. The changer will play the next file in the folder for 10 seconds, then scan again. To select a file, select **“SCAN”** on the screen a second time. If the changer reaches the end of the folder, it will continue scanning from file 1.

After all the files are scanned in one pass, normal play resumes.

SEARCHING FOR A DESIRED FOLDER

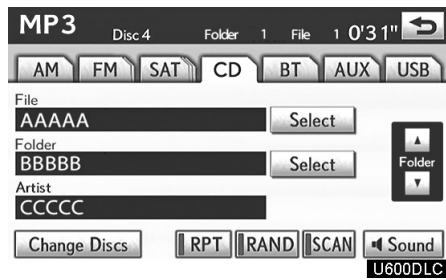

Select **“SCAN”** on the screen for longer than a second while the disc is playing.

“FLD.SCAN” appears on the screen. The program at the beginning of each folder will be played for 10 seconds. To continue listening to the program of your choice, select **“SCAN”** on the screen a second time.

After all the folders are scanned in one pass, normal play resumes.

OTHER FUNCTIONS

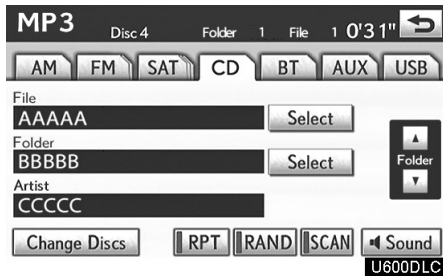

“**RPT**”: Use it for automatic repeat of the file or folder you are currently listening to.

Repeating a file —

Select “**RPT**” briefly while the file is playing. “**RPT**” appears on the screen. When the file is finished, the changer will automatically go back to the beginning of the file and play the file again. To cancel it, select “**RPT**” once again.

Repeating a folder —

Select “**RPT**” for longer than a second while the folder is playing. “**FLD.RPT**” appears on the screen. When the folder is finished, the changer will automatically go back to the beginning of the folder and play the folder again. To cancel it, select “**RPT**” once again.

“**RAND**”: Use it for automatic and random selection of the folder or the disc which you are currently listening to.

Playing the files in one folder in random order —

Select “**RAND**” briefly while the disc is playing. “**RAND**” appears on the screen. The system selects a file in the folder you are currently listening to. To cancel it, select “**RAND**” once again.

Playing the files in all the folders on one disc in random order —

Select “**RAND**” for longer than a second while the disc is playing. “**FLD.RAND**” appears on the screen. The system selects a file in all the folders. To cancel it, select “**RAND**” once again.

When a file is skipped or the system is inoperative, select “**RAND**” to reset.

(g) If the changer malfunctions

If “CD error” appears on the screen, audio signals of the disc cannot be read or the system has trouble. Push the “**CD**” button once again.

If the changer does not operate, check that the disc surface is not soiled or damaged. If the disc is O.K., the temperature of the changer’s internal mechanism may be raised because of high external temperature. Remove the disc from the changer to cool it.

If the changer still does not operate, have it checked by your dealer.

If an MP3/WMA disc contains CD-DA files, only CD-DA files are played. If an MP3/WMA disc contains files other than CD-DA, only MP3/WMA files are played.

— DVD changer operation

For safety reasons, you can enjoy DVD video discs, DVD audio discs and video CDs only when the vehicle is completely stopped with the “POWER” switch is in ACCESSORY or ON mode and the parking brake applied. While you are driving, you can hear audio alone even in the DVD video, DVD audio or video CD mode.

(a) Inserting discs

The "POWER" switch must be in ACCESSORY or ON mode.

Your DVD changer can store up to 6 discs.

You can set a disc at the lowest empty disc number.

● **Setting a single disc:**



1. Push the "LOAD" button briefly.

The amber indicators at both ends of the slot start blinking. After the amber indicators change to green and stay on, the DVD changer door will open.

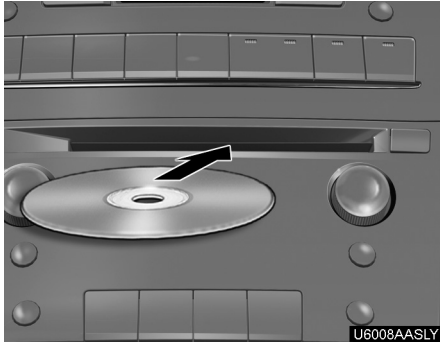

2. Insert only one disc while the DVD changer door is open.

You can set a disc at the lowest empty disc number.

After insertion, the set disc is automatically loaded.

If the label faces down, the disc cannot be played. In this case, "Check disc ×" appears on the screen.

If you do not insert the disc within 15 seconds after pushing the "LOAD" button, a beep will sound and the operation will be canceled automatically.

If you need to insert the next disc, repeat the same procedure to insert another disc.

● **Setting all the discs:**



1. Push the "LOAD" button until you hear a beep.

The amber indicators at both ends of the slot start blinking. After the amber indicators change to green and stay on, the DVD changer door will open.

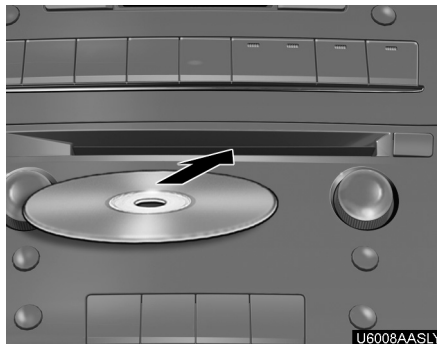

2. Insert only one disc while the DVD changer door is open.

The DVD changer door closes and the amber indicators start blinking.

3. Insert the next disc after the amber indicators change to green and stay on and the DVD changer door opens.

4. Repeat this procedure until you insert all the discs.

To cancel the operation, push the “LOAD” button briefly.

If you do not insert the discs within 15 seconds after pushing the “LOAD” button, the beep will sound and the operation will be canceled automatically.

NOTICE

Do not insert one disc stacked on top of another one or feed them in continuously, to prevent discs from getting stuck in the changer.

(b) Ejecting discs

- A single disc alone:

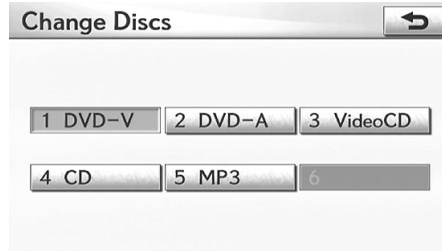

U6074LC



U6009AASLY

1. Push the “^” or “v” button of the “CH/DISC” or select the disc number button on the “Change Discs” screen to highlight the disc number you want to eject.

To display the “Change Discs” screen, select “Change Discs” on each audio control screen.



2. Push the “▲” button for the disc briefly.

At this time, the amber indicators of the slot start blinking and the disc is ejected.

3. After the blinking indicators stay on, remove the disc.

● **Ejecting all the discs:**



1. Push the “▲” button for the disc until you hear a beep.

At this time, the amber indicators of the slot start blinking and a disc is ejected.

2. After the blinking indicators stay on, remove the disc.

The indicators start blinking again and the next disc is ejected.

If you do not remove the disc within 15 seconds after it is ejected, the beep will sound and the operation will be canceled automatically.

When all the discs are removed, the indicators go out.

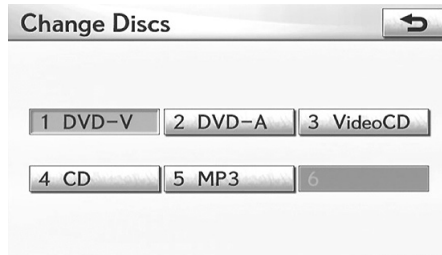

The numbers of the trays where the disc is not set are dimmed.

(c) Playing a disc

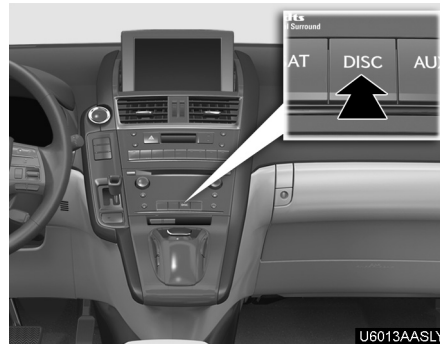

Push the “DISC” button to display audio screen and select “CD/DVD” tab if the discs are already loaded in the changer.

The discs set in the changer are played continuously, starting with the last disc you inserted. The disc number of the disc currently being played, the track or title and chapter number and the time from the beginning of the program appear on the screen.

Audio CD only —

When play of one disc ends, the first track of the following disc starts. When play of the final disc ends, play of the first disc starts again.

The changer will skip any empty disc trays.

(d) Selecting a desired disc

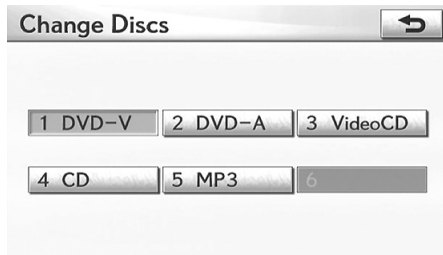

On the screen:

Select “CD/DVD” tab and select “Change Discs”.

The selected disc number is highlighted.

The changer will start playing the selected disc from the first track.

On the audio panel:

Push the “^” or “v” button of the “CH/DISC”.

When you release the button, the changer will start playing the selected disc from the first track.

(e) Operating a DVD disc

NOTE: The playback condition of some DVD discs may be determined by a DVD software producer. This DVD changer plays a disc as the software producer intended. So some functions may not work properly. Be sure to read the instruction manual for the DVD disc separately provided. For the detailed information about DVD video discs, see “(h) DVD player and DVD video disc information” on page 245.

Precautions on DVD video disc

When recording with a DVD video or video CD, audio tracks may not record in some cases while the menu is displayed. As audio will not play in this case, verify that the video tracks are playing and then activate playback.

When playback of a disc is completed:

- If an audio CD or MP3 disc is playing, the first track or file starts.
- If a DVD video or video CD is playing, playback will stop or the menu screen will be displayed.

The title/chapter number and playback time display may not appear while playing back certain DVD video discs.

 **CAUTION**

Conversational speech on some DVDs is recorded at a low volume to emphasize the impact of sound effects. If you adjust the volume assuming that the conversations represent the maximum volume level that the DVD will play, you may be startled by louder sound effects or when you change to a different audio source. The louder sounds may have a significant impact on the human body or pose a driving hazard. Keep this in mind when you adjust the volume.

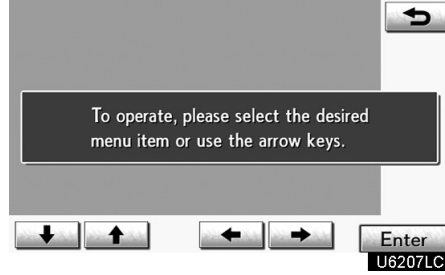

This screen appears when the video screen is first displayed after "POWER" switch is in ACCESSORY or ON mode.

AUDIO/VIDEO SYSTEM

PLAYING A DVD DISC



Select “CD/DVD” tab to display this screen.

Select “Settings” on “CD/DVD” screen and select “Wide” on “Settings” screen. The screen mode can be changed.

If you select “Full Screen” when the vehicle is completely stopped and the parking brake is applied, the video screen returns.

DVD SETTINGS

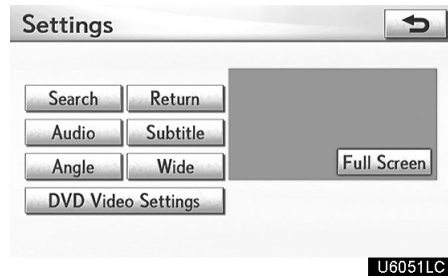

► DVD video

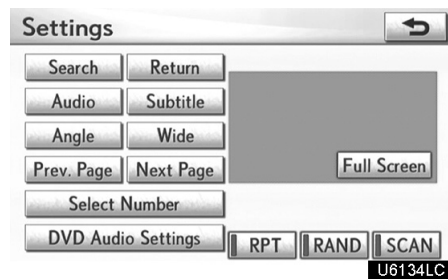

► DVD audio

If you select “Settings” on “DVD” screen, “Settings” screen appears.

DESCRIPTION OF DVD VIDEO SETTINGS

“DVD Video Settings”: The initial set up screen appears. (See page 238.)

“Search”: The title search screen appears. (See page 234.)

“Return”: Selecting this will display the predetermined scene and start playing from there.

“Audio”: The audio changing screen appears. (See page 236.)

“Subtitle”: The subtitle changing screen appears. (See page 236.)

“Angle”: The angle selection screen appears. (See page 237.)

“Wide”: The screen mode screen appears. (See page 195.)

DESCRIPTION OF DVD AUDIO SETTINGS

“DVD Audio Settings”: The initial set up screen appears. (See page 238.)

“Search”: The group search screen appears.

“Return”: Selecting this will display the predetermined scene and start playing from there.

“Audio”: The audio changing screen appears. (See page 237.)

“Subtitle”: The subtitle changing screen appears. (See page 236.)

“Angle”: The angle selection screen appears. (See page 237.)

“Wide”: The screen mode screen appears. (See page 195.)

“Prev. Page”: Select this button to reverse the pages. (See page 235.)

“Next Page”: Select this button to forward the pages. (See page 235.)

“Select Number”: The track or number search screen appears. (See page 244.)

“RPT”: Select this button to repeat a track.

“RAND”: Select this button to play the track in one group in random order.

“SCAN”: Select this button to play the next track in the group for 10 seconds, then scan again.

DISPLAYING DVD CONTROLS

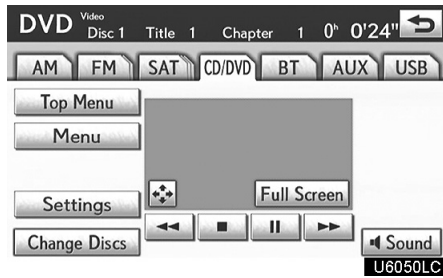

► **DVD video**

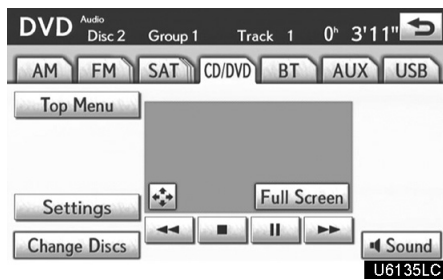

► **DVD audio**

If you select  , while watching video, DVD controls will appear.

If “” appears on the screen when you select a control, the operation relevant to the control is not permitted.

DESCRIPTION OF DVD VIDEO CONTROLS

“**Menu**” and “**Top Menu**”: If you select any of the above controls, the menu screen for DVD video appears. (For the operation, see the manual that come with the DVD video disc provided separately.)

 : The menu control key appears on the screen. (See page 233.)

 : Selecting this will pause the video screen.

 : Selecting this will fast reverse during playback.

 : Selecting this will stop the video screen.

 : Selecting this will resume normal play during pause.

 : Selecting this will fast forward during playback and forward frame by frame during pause.

DESCRIPTION OF DVD AUDIO CONTROLS

“Top Menu”: If you select this button, the menu screen for DVD audio appears. (For the operation, see the manual that come with the DVD audio disc provided separately.)

 : The menu control key appears on the screen. (See page 233.)

 : Selecting this will pause the disc.

 : Selecting this will fast reverse during playback.





 : Selecting this will stop the disc.

 : Selecting this will resume normal play during pause.

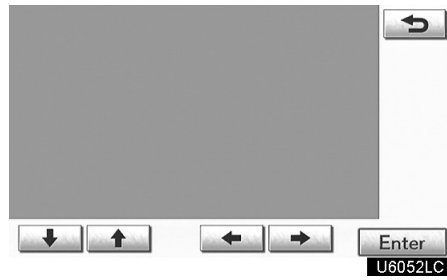
 : Selecting this will fast forward during playback and forward frame by frame during pause.

SELECTING A MENU ITEM



Enter the menu item using , ,  and  and select “Enter”. The player starts playing disc for that menu item. Menu items can also be selected using the pointer. (For details, see the manual that comes with the DVD disc provided separately.)

When you select the any point on the screen, the controls will disappear. To display them again, select the any point on the screen.

When you select , the previous screen returns.

SEARCHING BY TITLE

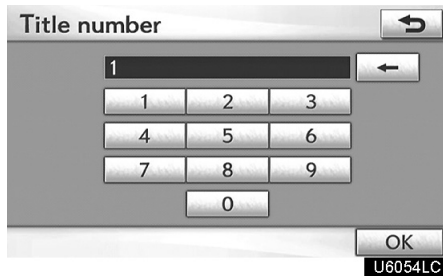

SEARCHING BY GROUP

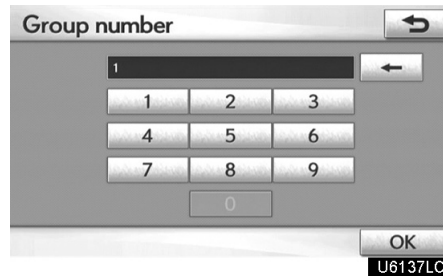

DVD audio only —

Enter the group number and select “OK”. The player starts playing the disc for that group number.

When you push the “^” or “v” button of the “SEEK/TRACK” button, you can select a track.

If you enter the wrong numbers, select  to delete the numbers.

When you select , the previous screen returns.

DVD video only—

Enter the title number and select “OK”. The player starts playing video for that title number.

When you push the “^” or “v” button of the “SEEK/TRACK” button, you can select a chapter.

If you enter the wrong numbers, select  to delete the numbers.

When you select , the previous screen returns.

SELECTING THE BONUS GROUP

DVD audio only —

Enter the bonus group number on the searching group screen and select “OK”.

The “Enter Key Code” screen will appear. To enter the number of the group you want to play, select the group number.

If you enter the wrong numbers, select  to delete the numbers.

When you select , the previous screen returns.

Select “OK” on the screen.

The player starts playing the disc from the selected bonus group number.

CHANGING THE PAGE

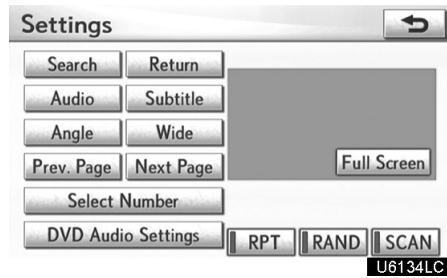

DVD audio only —

Select “Prev. Page” or “Next Page” on the screen to forward or reverse the pages.

CHANGING THE SUBTITLE LANGUAGE



U6068LC

Each time you select “Change”, the language is selected from the ones stored in the discs and changed.

When you select “Hide”, the subtitle can be hidden.

When you select , the previous screen returns.

CHANGING THE AUDIO LANGUAGE

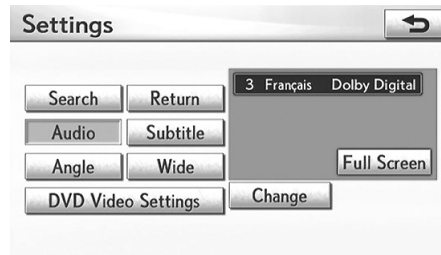

U6069LC

DVD video only —

Each time you select “Change”, the language is selected from the ones stored in the discs and changed.

When you select , the previous screen returns.

CHANGING THE AUDIO FORMAT

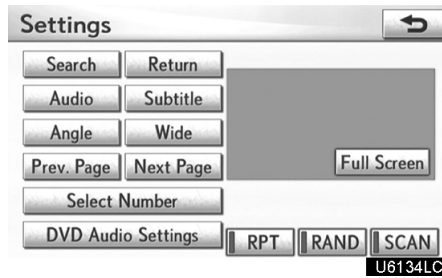

DVD audio only —

Each time you select “Audio”, another audio format stored on the disc is selected.

When you select , the previous screen returns.

CHANGING THE ANGLE

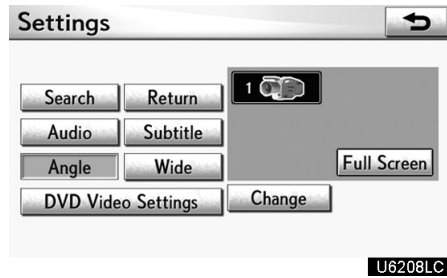

The angle can be selected for discs that are multi-angle compatible when the angle mark appears on the screen.

Each time you select “Change”, the angle is selected from the ones stored in the discs and changed.

When you select , and the previous screen returns.

SETUP MENU

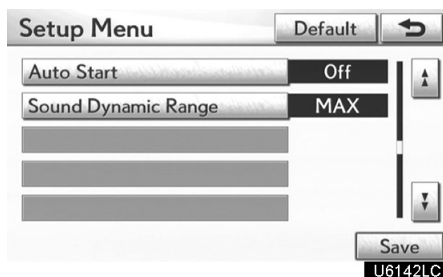
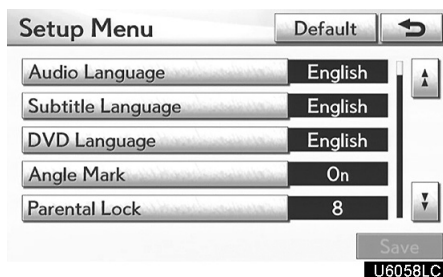

There are initial setting buttons on the “Setup Menu” screen.

After you change the initial setting, select . The initial setting screen will be turned off and return to the picture previously.

When “Default” is selected, all menus are initialized.

The initial setting can be changed.

● **Audio language**

You can change the audio language.

1. Select “Audio Language”.
2. Select the language you want to hear on the “Audio Language” screen.

If you cannot find the language you want to hear on this screen, select “Other” and enter a language code. For the entry of language code, see the following “ENTER AUDIO LANGUAGE CODE”.

To return to the “Setup Menu” screen, select .

● **Subtitle language**

You can change the subtitle language.

1. Select “Subtitle Language”.
2. Select a language you want to read on the “Subtitle Language” screen.

If you cannot find the language you want to read on this screen, select “Other” and enter a language code. For the entry of language code, see the following “ENTER AUDIO LANGUAGE CODE”.

To return to the “Setup Menu” screen, select .

● **DVD language**

You can change the language on the DVD video menu.

1. Select “DVD Language”.
2. Select the language you want to read on the “DVD Language” screen.

If you cannot find the language you want to read on this screen, select “Other” and enter a language code. For the entry of language code, see the following “ENTER AUDIO LANGUAGE CODE”.

To return to the “Setup Menu” screen, select .

- **Angle mark**

The multi-angle mark can be turned on or off on the screen while the disc which is multi-angle compatible is being played.

1. Select "Angle Mark".
2. Select "On" or "Off".

- **Parental lock**

The level of viewer restrictions can be changed.

1. Select "Parental Lock".
2. Enter the 4-digit personal code on the "Key code" screen.

If you enter the wrong numbers, select  to delete the numbers.

To return to the "Setup Menu" screen, select .

3. Select a parental level (1 — 8) on the "Select Restriction Level". Select  to return to the "Setup Menu" screen.

- **Auto start**

Discs that are inserted while the vehicle is in motion will automatically start playing. Certain discs may not play.

1. Select "Auto Start".
2. Select "On" or "Off".

- **Sound dynamic range (if equipped)**

The difference between the lowest volume and the highest volume can be adjusted.

1. Select "Sound Dynamic Range".
2. Select "MAX", "STD" or "MIN".

ENTER AUDIO LANGUAGE CODE

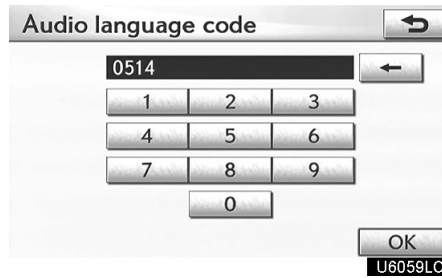

If you select "Other" on the "Select Audio Language" screen, "Select Subtitle Language" screen or "DVD Language" screen, you can select the language you want to hear or read by entering a language code.

1. Enter the 4-digit language code.

If you enter the wrong numbers, select  to delete the numbers.

2. Select "OK".

Code	Language
0514	English
1001	Japanese
0618	French
0405	German
0920	Italian
0519	Spanish
2608	Chinese
1412	Dutch
1620	Portuguese
1922	Swedish
1821	Russian
1115	Korean
0512	Greek
0101	Afar
0102	Abkhazian

AUDIO/VIDEO SYSTEM

0106	Afrikaans
0113	Amharic
0118	Arabic
0119	Assamese
0125	Aymara
0126	Azerbaijani
0201	Bashkir
0205	Byelorussian
0207	Bulgarian
0208	Bihari
0209	Bislama
0214	Bengali
0215	Tibetan
0218	Breton
0301	Catalan
0315	Corsican
0319	Czach
0325	Welsh
0401	Danish
0426	Bhutani
0515	Esperanto
0520	Estonian
0521	Basque
0601	Persian
0609	Finnish
0610	Fiji
0615	Faroese
0625	Frisian
0701	Irish
0704	Scots-Gaelic
0712	Galician
0714	Guarani

0721	Gujarati
0801	Hausa
0809	Hindi
0818	Croatian
0821	Hungarian
0825	Armenian
0901	Interlingua
0905	Interlingue
0911	Inupiak
0914	Indonesian
0919	Icelandic
0923	Hebrew
1009	Yiddish
1023	Javanese
1101	Georgian
1111	Kazakh
1112	Greenlandic
1113	Cambodian
1114	Kannada
1119	Kashmiri
1121	Kurdish
1125	Kirghiz
1201	Latin
1214	Lingala
1215	Laothian
1220	Lithuanian
1222	Latvian
1307	Malagasy
1309	Maori
1311	Macedonian
1312	Malayalam
1314	Mongolian

AUDIO/VIDEO SYSTEM

1315	Moldavian	1920	Sesotho
1318	Marathi	1921	Sundanese
1319	Malay	1923	Swahili
1320	Maltese	2001	Tamil
1325	Burmese	2005	Telugu
1401	Nauru	2007	Tajik
1405	Nepali	2008	Thai
1415	Norwegian	2009	Tigrinya
1503	Occitan	2011	Turkmen
1513	(Afan)Oromo	2012	Tagalog
1518	Oriya	2014	Setswana
1601	Panjabi	2015	Tonga
1612	Polish	2018	Turkish
1619	Pashto, Pushto	2019	Tsonga
1721	Quechua	2020	Tatar
1813	Rhaeto–Romance	2023	Twi
1814	Kirundi	2111	Ukrainian
1815	Romanian	2118	Urdu
1823	Kinyarwanda	2126	Uzbek
1901	Sanskrit	2209	Vietnamese
1904	Sindhi	2215	Volapük
1907	Sangho	2315	Wolof
1908	Serbo–Croatian	2408	Xhosa
1909	Sinhalese	2515	Yoruba
1911	Slovak	2621	Zulu
1912	Slovenian		
1913	Samoan		
1914	Shona		
1915	Somali		
1917	Albanian		
1918	Serbian		
1919	Siswati		

(f) Operating a video CD
PLAYING A VIDEO CD

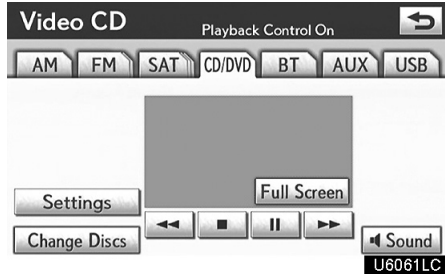

Select “CD/DVD” tab to display this screen.

When you select “Wide” on “Settings” screen, the screen mode can be changed. If you select “Full Screen” when the vehicle is completely stopped and the parking brake is applied, the video screen returns.

DISPLAYING VIDEO CD SETTINGS

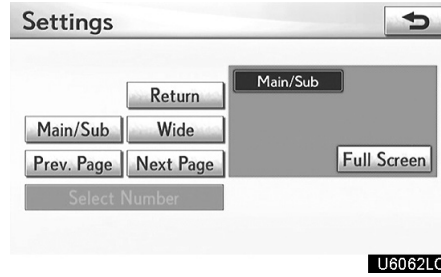

If you select “Settings” on “Video CD” screen, “Settings” screen appears.

DESCRIPTION OF VIDEO CD SETTINGS

● **Controls on top page**

“Select Number”: The track or number search screen appears. (See “SEARCHING BY TRACK” on page 244.)

“Prev. Page”: When you select this while the disc menu is displayed, the previous page appears on the screen. If you select this while the player is playing video, the previous track is searched and played.

“Next Page”: When you select this while the disc menu is displayed, the next page appears on the display. If you select this while the player is playing video, the next track is searched and played.

“Main/Sub”: A multiplex transmission changing control. The mode changes from Main/Sub to Main, to Sub and back to Main/Sub by selecting this control.

“Return”: Selecting this will display the predetermined scene and start playing from there.

“Wide”: The screen mode screen appears.

DISPLAYING VIDEO CD CONTROLS

If you select the part where controls are not located while you are watching video on the video CD, video CD controls will appear.

If “” appears on the display when you select a control, the operation is not permitted.

AUDIO/VIDEO SYSTEM

DESCRIPTION OF VIDEO CD CONTROLS

 : Use this to pause the video screen.

 : Select this to fast reverse during playback.

 : Select this to resume playing during pause.

 : Select this to fast forward during the playback and start playing frame by frame during pause.

SEARCHING BY TRACK

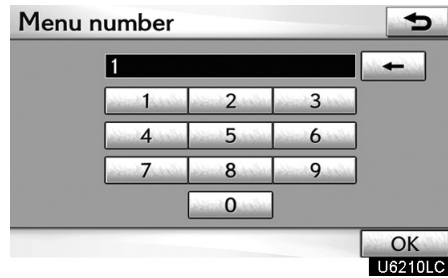

Enter the track numbers and select "OK". The player starts playing video for that title number.

You can select a track number by pushing " \wedge " or " \vee " on the "SEEK/TRACK" button.

If you enter the wrong numbers, select  to delete the numbers.

Select , and the previous screen returns.

(g) If the changer malfunctions

If the changer or another unit equipped with the changer malfunction, your audio/video system will display following messages.

If “Check disc ×” appears on the display: It indicates that the disc dirty, damaged, or it was inserted upside down. Clean the disc or insert it correctly. If a disc which is not playable is inserted, “Check disc ×” will also appear on the screen. For appropriate discs for this changer, see “Audio/video system operating hints” on page 265.

If “Region code error” appears on the display: It indicates that the DVD region code is not set properly.

If “DVD error” appears on the display: It indicates that the inside of the player unit may be too hot due to the very high ambient temperature. Remove the disc from the player and allow the player to cool down.

If the malfunction is not rectified: Take your vehicle to your dealer.

If an MP3 disc contains CD-DA files, only CD-DA files are played. If an MP3 disc contains files other than CD-DA, only MP3 files are played.





(h) DVD player and DVD video disc information

DVD VIDEO DISCS

This DVD player conforms to NTSC color TV formats. The DVD video disc conforming to another formats such as PAL or SECAM cannot be used.

Region codes: Some DVD video discs have a region code indicating a country where you can use the DVD video disc on this DVD player. If the DVD video disc is not labeled as “ALL” or “1”, you cannot use it on this DVD player. If you attempt to play an inappropriate DVD video disc on this player, “Region code error” appears on the screen. Even if the DVD video disc does not have a region code, there is a case that you cannot use it.

Marks shown on DVD video discs:

NTSC	Indicates NTSC format of color TV.
	Indicates the number of audio tracks.
	Indicates the number of language subtitles.
	Indicates the number of angles.
	Indicates the screen to be selected. Wide screen: 16:9 Standard: 4:3
	Indicates a region code by which this video disc can be played. ALL: in all countries Number: region code

DVD VIDEO DISC GLOSSARY

DVD video discs: Digital Versatile Disc that holds video. DVD video discs have adopted “MPEG2”, one of the world standards of digital compression technologies. The picture data is compressed by 1/40 on average and stored. Variable rate encoded technology in which the volume of data assigned to the picture is changed depending on the picture format has also been adopted. Audio data is stored using PCM and Dolby Digital, which enables higher quality of sound. Furthermore, multi-angle and multi-language features will also help you enjoy the more advanced technology of DVD video.

Viewer restrictions: This feature limits what can be viewed in conformity with a level of restrictions of the country. The level of restrictions varies depending on the DVD video disc. Some DVD video discs cannot be played at all, or violent scenes are skipped or replaced with other scenes.

Level 1: DVD video discs for children can be played.

Level 2 – 7: DVD video discs for children and G-rated movie can be played.

Level 8: All types of the DVD video discs can be played.

Multi-angle feature: You can enjoy the same scene at different angles.

Multi-language feature: You can select a language of the subtitle and audio.

Region codes: The region codes are provided on DVD players and DVD discs. If the DVD video disc does not have the same region code as the DVD player, you cannot play the disc on the DVD player. For region codes, see page 246.

Audio: This DVD player can play liner PCM, Dolby Digital and MPEG audio format DVD. Other decoded type cannot be played.

Title and chapter: Video and audio programs stored in DVD video disc are divided in parts by title and chapter.

Title: The largest unit of the video and audio programs stored on DVD video discs. Usually, one piece of movie, one album, or one audio program is assigned as a title.

Chapter: The unit smaller than that of title. A title comprises plural chapters.

Manufactured under license from Dolby Laboratories. “Dolby”, “Pro Logic”, and the double-D symbol are trademarks of Dolby Laboratories.

This product incorporates copyright protection technology that is protected by method claims of certain U.S. patents and other intellectual property rights owned by Macrovision Corporation and other rights owners. Use of this copyright protection technology must be authorized by Macrovision Corporation, and is intended for home and other limited viewing uses only unless otherwise authorized by Macrovision Corporation. Reverse engineering or disassembly is prohibited.

“DTS” and “DTS Digital Surround” are registered trademarks of Digital Theater Systems, Inc.

— Bluetooth® audio operation

The Bluetooth® audio system enables users to enjoy music played on a portable player from the vehicle speaker via wireless communication.

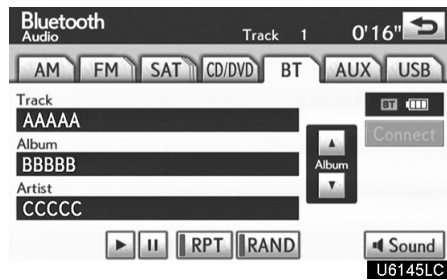

This audio system supports Bluetooth®, a wireless data system capable of playing portable audio music without cables. If your portable player does not support Bluetooth®, the Bluetooth® audio system will not function.

INFORMATION

Portable players must correspond to the following specifications in order to be connected to the Bluetooth® audio system. However, please note that some functions may be limited depending on the type of portable player.

- **Bluetooth® Specification**
*Ver.1.1 or higher
(Recommended: Ver.2.0+EDR or higher)*
- **Profile**
 - *A2DP (Advanced Audio Distribution Profile) Ver.1.0 or higher*
 - *AVRCP (Audio/Video Remote Control Profile) Ver.1.0 or higher
(Recommended: Ver.1.3 or higher)*

Please go to “<http://www.lexus.com/>” to find approved Bluetooth® phones for this system.



Bluetooth is a trademark owned by Bluetooth SIG, Inc.

CAUTION

Do not operate the player's controls or connect to the Bluetooth® audio system while driving.

NOTICE

Do not leave your portable player in the car. In particular, high temperatures inside the vehicle may damage the portable player.

INFORMATION

- **In the following conditions, the system may not function.**
 - *The portable player is turned off.*
 - *The portable player is not connected.*
 - *The portable player has a low battery.*
- **It may take time, the phone connection is carried out during Bluetooth® audio play.**

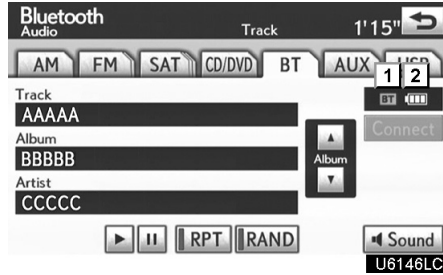

1 Indicates the condition of the Bluetooth® connection.

“**Blue**” indicates an excellent connection to Bluetooth®.

“**Yellow**” indicates a bad connection to Bluetooth®, resulting in possible deterioration of audio quality.

BT : No connection to Bluetooth®.

2 Indicates the amount of battery charge left.



Remaining charge is not displayed while the Bluetooth® is connecting.

The amount left does not always correspond with the one of your portable player. This system doesn't have a charging function.

An antenna for the Bluetooth® connection is built in to the instrument panel. The indication of the Bluetooth® connection may turn yellow and the system may not function when you use the Bluetooth® portable player in the following conditions.

- Your portable player is hiding behind from the display (behind the seat or in the glove box or console box).
- Your portable player touches or is covered with metal materials.

Leave the Bluetooth® portable player in a place where the “Blue” indication is displayed.

The portable player information is registered when the Bluetooth® audio system is connected. When you release possession of your vehicle, remove your portable player. (See “(a) Removing a Bluetooth® audio” on page 377.)

FCC ID : AJDK021
IC : 775E-K021

This device complies with Part 15 of the FCC Rules and RSS-Gen and RSS-210 of IC Rules. Operation is subject to the following two conditions : (1) This device may not cause harmful interference, and (2) this device must accept any interference received, including interference that may cause undesired operation.

 **CAUTION**

FCC WARNING: Changes or modifications not expressly approved by the party responsible for compliance could void the user's authority to operate the equipment.

CAUTION: Radio Frequency Radiation Exposure

This equipment complies with FCC radiation exposure limits set forth for uncontrolled equipment and meets the FCC radio frequency (RF) Exposure Guidelines in Supplement C to OET65. This equipment has very low levels of RF energy that it deemed to comply without maximum permissive exposure evaluation (MPE). But it is desirable that it should be installed and operated with at least 20 cm and more between the radiator and person's body (excluding extremities: hands, wrists, feet and ankles).

Co-location: This transmitter must not be co-located or operated in conjunction with any other antenna or transmitter.

(a) **Connecting Bluetooth® audio player**

To use the Bluetooth® audio system, you need to enter your portable player into the system. Once you have registered it, you can enjoy your music on the vehicle's audio system. (See "—Setting Bluetooth® audio" on page 375.)

For the operation procedure for the portable player, see the instruction manual that comes with it.

- When the connection method is "From Vehicle".
 - When the auto connection is on
When the portable player is standby for the connection, it will be automatically connected whenever the "POWER" switch is in either ACCESSORY or ON mode.
 - When the auto connection is off
Manually connect the portable player in accordance with the following procedure.



Select "Connect".



U6033LC

When the connection is completed, this screen is displayed. Now you can use the portable player.



U6034LC

This screen will appear when the connection has failed.

- When the connection method is "From Portable Player"

Operate the portable player and connect it to the Bluetooth® audio system. For the operation procedure for the portable player, see the instruction manual that comes with it.

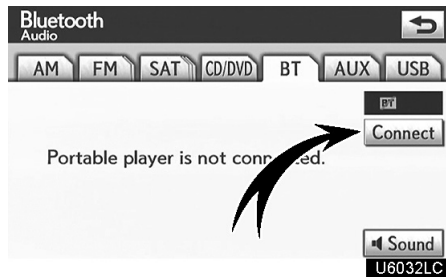

Select "Connect".



U6035LC

Connect the portable audio player to the Bluetooth® audio system.



U6036LC

This screen will appear when the connection has been successfully established.

- **Reconnecting the portable player**

If the portable player is disconnected with a poor reception from the Bluetooth® network when the “POWER” switch is in ACCESSORY or ON mode, the system automatically reconnects the portable player.

If the Bluetooth® is disconnected on purpose such as you turned your portable player off, this does not happen.

Reconnect it by the following method.

- **Select the portable player again.**
- **Enter the portable player.**

(b) Playing a Bluetooth® audio

- **Playing and pausing a Bluetooth® audio**

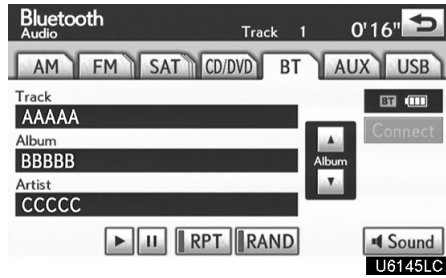



Select “BT” tab if the Bluetooth® audio player is already connected.

Select  and the music will start playing.

Select  and the music will pause.

Select  and the music will start playing again.

Depending on the portable player that is connected to the system, the music may start playing when selecting  while it is paused. On the other hand, the music may pause when selecting  while it is playing.

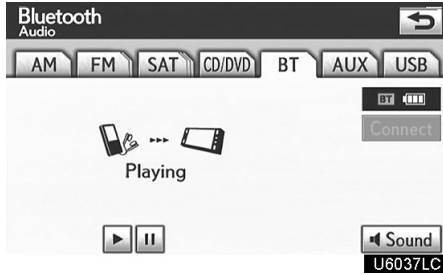

Some titles may not be displayed depending on the type of portable player.

• **Selecting a desired track**



“SEEK/TRACK” button: Use for direct access to a desired track.

Push the “^” or “v” button of the “SEEK/TRACK” button and repeat it until the desired track number appears on the screen. As you release the button, the portable player will start playing the selected track from the beginning.

Fast forward:

Push and hold the “^” button of “SEEK/TRACK” to fast forward the player. When you release the button, the portable player will resume playing from that position.

Reverse:

Push and hold the “v” button of “SEEK/TRACK” to reverse the player. When you release the button, the player will resume playing.

INFORMATION

Depending on the portable player that is connected to the system, certain functions may not be available.

● **Selecting a desired album**

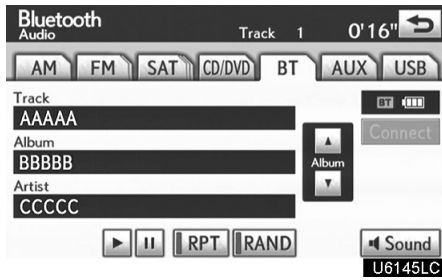

“Album ▲”: Select this button to go to the next album.

“Album ▼”: Select this button to go to the previous album.

INFORMATION

Depending on the portable player that is connected to the system, certain functions may not be available.

● **Other function**

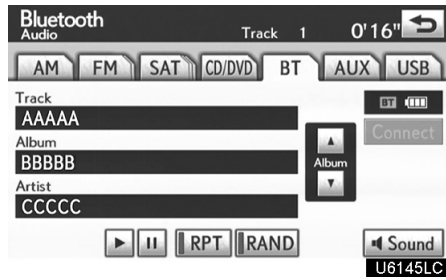

“RPT”: Use this control to automatic re-play the track you are currently listening to.

Repeating a track—

While the track is playing, select “RPT” briefly.

“RPT” appears on the screen. When the track is finished, the player will automatically play it again. To cancel the repeat, select “RPT” once again.

“**RAND**”: Use this for automatic and random selection of tracks on the album that you are currently listening to.

Playing the tracks in the album in random order—

While the track is playing, select “RAND” briefly.

“RAND” appears on the screen. The system selects a track in the album you are currently listening to. To cancel this function, select “RAND” once again.

INFORMATION

Depending on the portable player that is connected to the system, certain functions may not be available.

—USB memory/iPod operation

Connecting a USB memory or iPod enables you to enjoy music from the vehicle speakers.



CAUTION

Do not operate the player's controls or connect the USB memory or iPod while driving.

NOTICE

- ***Do not leave your portable player in the car. In particular, high temperatures inside the vehicle may damage the portable player.***
- ***Do not push down on or apply unnecessary pressure to the portable player while it is connected as this may damage the portable player or its terminal.***
- ***Do not insert foreign objects into the port as this may damage the portable player or its terminal.***

(a) Connecting a USB memory or iPod

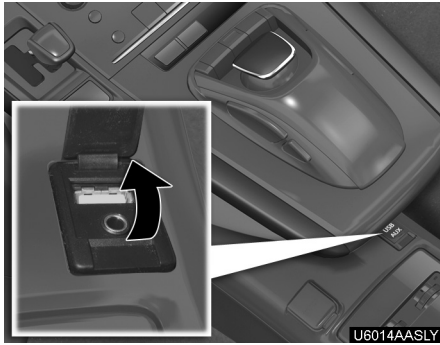

Open the cover and connect a USB memory or iPod using an iPod cable.

Turn on the power of the USB memory or iPod if it is not turned on.

(b) Playing a USB memory or iPod

● Playing and pausing a file or track

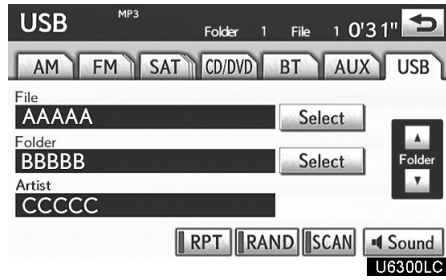

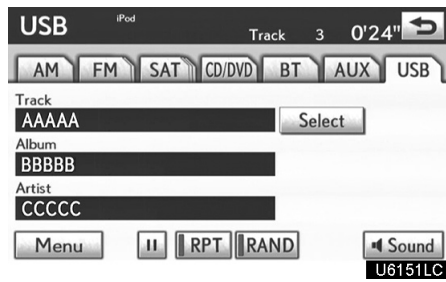

▶ USB memory



▶ iPod

Select “USB” tab to display this screen if the USB memory or iPod is already connected.

Select  and the music will start playing.

Select  and the music will pause.

Select  and the music will start playing again.

INFORMATION

- When an iPod is connected and the audio source is changed to iPod mode, the iPod will resume play from the same point in which it was last used.
- When the USB memory is connected and the audio source is changed to USB memory mode, the USB memory will start playing the first file in the first folder. If the same device is removed and reinserted (and the contents have not been changed), the USB memory will resume play from the same point in which it was last used.
- Depending on the iPod or USB memory that is connected to the system, certain functions may not be available.

• Selecting a play mode (iPod only)

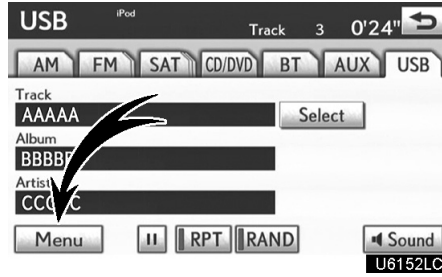

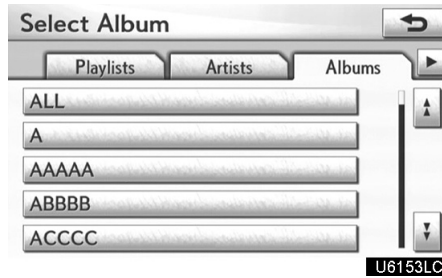

1. Select "Menu".

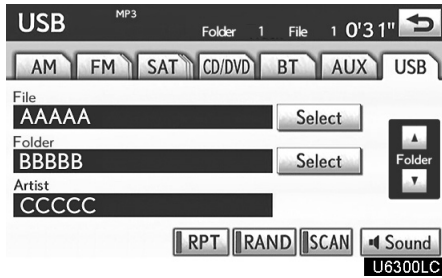

2. Select the desired play mode.

● **Selecting a desired folder (USB memory only)**



 : By selecting this button, the list moves down by 5 folder groups. If this button is selected when the last page of the list is displayed, the top page is displayed.

“**Folder▲**” : Select this button to go to the next folder.

“**Folder▼**” : Select this button to go to the previous folder.

“**Select**” for Folder: The desired folder can be selected in a list. This function is available only when the vehicle is not moving.

Select “**Select**”. The folder list is displayed.

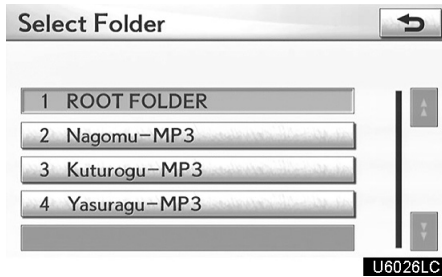

Select the desired folder number. The changer will start playing the first file of the selected folder.

 : By selecting this button, the list moves up by 5 folder groups. If this button is selected when the top page of the list is displayed, the last page is displayed.

● **Selecting a desired file or track**



“SEEK/TRACK” button: Use for direct access to a desired file or track.

Push the “^” or “v” button of the “SEEK/TRACK” button and repeat it until the desired file or track appears on the screen. As you release the button, the USB memory or iPod will start playing the selected file or track from the beginning.

Fast forward:

Push and hold the “^” button of “SEEK/TRACK” to fast forward the player. When you release the button, the player will resume playing from that position.

Reverse:

Push and hold the “v” button of “SEEK/TRACK” to reverse the player. When you release the button, the player will resume playing.



“TUNE/FILE” knob: Use for direct access to a desired file or track in the player.

Turn the “TUNE/FILE” knob to step up or down all the files or tracks in the player you are currently listening to.

AUDIO/VIDEO SYSTEM

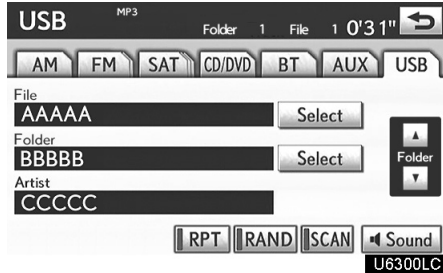

► USB memory

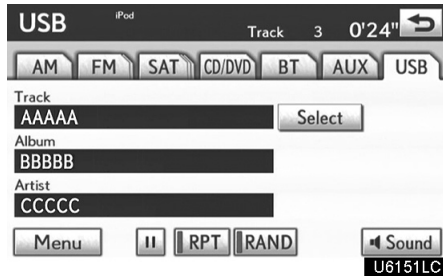

► iPod

“Select” for File or Track: The desired file or track can be selected in a list. This function is available only when the vehicle is not moving.

Select **“Select”**. The file or track list is displayed.

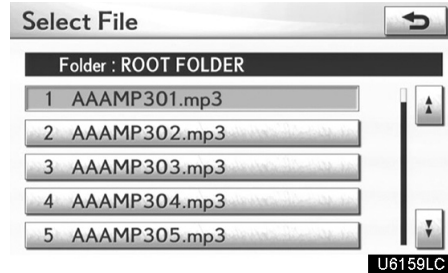

Select the desired file or track number. The changer will start playing the selected file or track from the beginning.

 : By selecting this button, the list moves up by 5 file or track groups. If this button is selected when the top page of the list is displayed, the last page is displayed.

 : By selecting this button, the list moves down by 5 file or track groups. If this button is selected when the last page of the list is displayed, the top page is displayed.

- **Searching for a desired file (USB memory only)**

Select **“SCAN”** on the screen briefly while the music is playing.

“SCAN” appears on the screen. The player will play the next file for 10 seconds, then scan again. To select a file, select **“SCAN”** on the screen a second time. If the player reaches the end of the memory, it will continue scanning at file1.

After all the files are scanned in one pass, normal play resumes.

- **Searching for a desired folder (USB memory only)**

Select **“SCAN”** on the screen for longer than a second while the music is playing.

“FLD.SCAN” appears on the screen. The program at the beginning of each folder will be played for 10 seconds. To continue listening to the program of your choice, select **“SCAN”** on the screen a second time.

After all the folders are scanned in one pass, normal play resumes.

• Other function

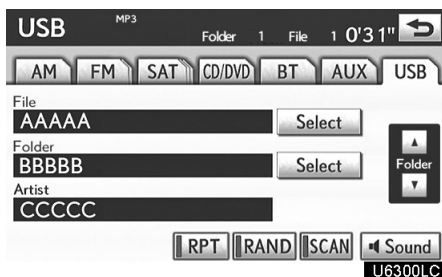

► USB memory

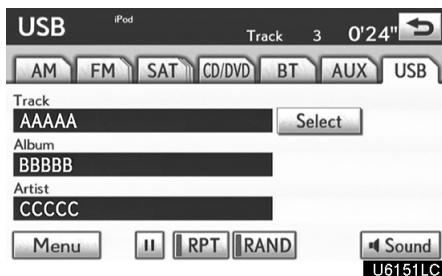

► iPod

“RPT”: Use this control to automatic re-play the file or track you are currently listening to.

Repeating a file or track—

While the file or track is playing, select “RPT” briefly.

“RPT” appears on the screen. When the file or track is finished, the player will automatically play it again. To cancel the repeat, select “RPT” once again.

Repeating a folder (USB memory only)

While the folder is playing, select “RPT” for longer than a second.

“FLD.RPT” appears on the screen. When the folder is finished, the changer will automatically go back to the beginning of the folder and play the folder again. To cancel it, select “RPT” once again.

“RAND”: Use this for automatic and random selection of files or tracks on the album that you are currently listening to.

Playing the file or track in random order—

While the file or track is playing, select “RAND” briefly.

“RAND” appears on the screen. The system selects a file or track you are currently listening to. To cancel this function, select “RAND” once again.

Playing the files in all files in random order —

Select “RAND” for longer than a second while the music is playing. “FLD.RAND” appears on the screen. The system selects a file in all files. To cancel it, select “RAND” once again.

When a file is skipped or the system is in-operative, select “RAND” to reset.

Audio/video remote controls (steering switches)



Some parts of the audio system can be adjusted using the switches on the steering wheel.

Details of the specific switches, controls, and features are described below.

- 1** Volume control switch
- 2** “**MODE**” switch
- 3** “**^** **v**” switch

1 Volume control switch

Push “**+**” side to increase the volume. The volume continues to increase while the switch is being pressed.

Push “**-**” side to decrease the volume. The volume continues to decrease while the switch is being pressed.

2 “**MODE**” switch

Push “**MODE**” switch to select an audio mode. Each push changes the mode sequentially if the desired mode is ready to use.

To turn the audio/video system on, push the “**MODE**” switch.

To turn the audio/video system off, push and hold the “**MODE**” switch until you hear a beep.

3 “**^** **v**” switch

Radio

This switch has the following features—

To select a preset station:

Quickly push and release the “**^**” or “**v**” side of the switch. Do this again to select the next preset station.

To seek a station:

Push and hold the “**^**” or “**v**” side of the switch until you hear a beep. Do this again to find the next station. If you push the switch on either side during the seek mode, seeking will be cancelled.

To step up or down the frequency, push and hold the switch even after you hear a beep. When you release from the switch, the radio will begin seeking up or down for a station. Do this again to find the next station.

XM® Satellite Radio (if equipped)—

To select a preset channel, push the “**^**” or “**v**” side of the switch. Repeat until a desired channel is found.

CD changer or DVD changer

Use this switch to skip up or down to a different track, file or chapter in either direction.

To select a desired track, file or chapter: Quickly push and release the “^” or “v” side of the switch until the track, file or chapter you want to play is set. If you want to return to the beginning of the current track, file or chapter, push the “v” side of the switch once, quickly.

To select a desired disc: Push and hold the “^” or “v” switch until you hear a beep to change to the next or the previous disc. Repeat this operation until you reach the disc you want to listen to.

Bluetooth® audio player

Use this switch to skip up or down to a different track or album in either direction.

To select a desired track: Quickly push and release the “^” or “v” side of the switch until the track you want to listen to is set. If you want to return to the beginning of the current track, push the “v” side of the switch once quickly.

To select a desired album: Push and hold “^” or “v” switch until you hear a beep to change to the next or the previous album. Repeat this operation until you reach the album you want to listen to.

USB memory/iPod

Use this switch to skip up or down to a different file or track in either direction.

To select a desired file or track: Push the “^” or “v” side of the switch until the file or track you want to listen to is set. If you want to return to the beginning of the current file or track, push the “v” side of the switch once quickly.

To select a desired folder (USB memory player only):

Push and hold “^” or “v” switch until you hear a beep to change to the next or the previous folder. Repeat this operation until you reach the folder you want to listen to.

Audio/video system operating hints

NOTICE

To ensure correct audio/video system operations:

- *Be careful not to spill beverages over the audio/video system.*
- *Do not put anything other than an appropriate discs into the CD changer or DVD changer.*
- *The use of a cellular phone inside or near the vehicle may cause a noise from the speakers of the audio/video system which you are listening to. However, this does not indicate a malfunction.*

● Radio reception

Usually, a problem with radio reception does not mean there is a problem with your radio — it is just the normal result of conditions outside the vehicle.

For example, nearby buildings and terrain can interfere with FM reception. Power lines or telephone wires can interfere with AM signals. And of course, radio signals have a limited range. The farther you are from a station, the weaker its signal will be. In addition, reception conditions change constantly as your vehicle moves.

Here are some common reception problems that probably do not indicate a problem with your radio:

FM

Fading and drifting stations — Generally, the effective range of FM is about 25 miles (40 km). Once outside this range, you may notice fading and drifting, which increase with the distance from the radio transmitter. They are often accompanied by distortion.

Multi-path — FM signals are reflective, making it possible for two signals to reach your antenna at the same time. If this happens, the signals will cancel each other out, causing a momentary flutter or loss of reception.

Static and fluttering — These occur when signals are blocked by buildings, trees, or other large objects. Increasing the bass level may reduce static and fluttering.

Station swapping — If the FM signal you are listening to is interrupted or weakened, and there is another strong station nearby on the FM band, your radio may tune in the second station until the original signal can be picked up again.

AM

Fading — AM broadcasts are reflected by the upper atmosphere — especially at night. These reflected signals can interfere with those received directly from the radio station, causing the radio station to sound alternately strong and weak.

Station interference — When a reflected signal and a signal received directly from a radio station are very nearly the same frequency, they can interfere with each other, making it difficult to hear the broadcast.

Static — AM is easily affected by external sources of electrical noise, such as high tension power lines, lightening, or electrical motors. This results in static.

AUDIO/VIDEO SYSTEM

XM®(if equipped)

Cargo loaded on the roof luggage carrier, especially metal objects, may adversely affect the reception of XM® Satellite Radio.

Alteration or modifications carried out without appropriate authorization may invalidate the user's right to operate the equipment.

iPod

About iPod —

- Apple is not responsible for the operation of this device or its compliance with safety and regulatory standards.
- iPod is a trademark of Apple Inc., registered in the U.S. and other countries.

Compatible models —

Model	Generation	Software version
iPod	5th generation	Ver. 1.2.0 or higher
iPod nano	1st generation	Ver. 1.3.0 or higher
	2nd generation	Ver. 1.1.2 or higher
	3rd generation	Ver. 1.0.0 or higher
iPod touch	1st generation	Ver. 1.1.0 or higher
iPod classic	1st generation	Ver. 1.0.0 or higher

Depending on differences between models or software versions etc., some models listed above might be incompatible with this system.

iPod 4th generation and earlier models are not compatible with this system.

iPhone, iPod mini, iPod shuffle and iPod photo are not compatible with this system.

USB memory

USB memory that can be used for MP3 and WMA playback.

- USB communication formats: USB 2.0 FS (12 MBPS)
- File formats: FAT 16/32 (Windows®)
- Correspondence class: Mass storage class

CARING FOR YOUR CD CHANGER, DVD CHANGER AND DISCS

- Your CD changer and DVD changer is intended for use with 4.7 in. (12 cm) discs only.
- Extremely high temperatures can keep your CD changer and DVD changer from working. On hot days, use the air conditioning to cool the vehicle interior before you use the changer and player.
- Bumpy roads or other vibrations may make your CD changer and DVD changer skip.
- If moisture gets into your CD changer and DVD changer, you may not play even though they appear to be working. Remove the discs from the changer and wait until it dries.

CD changer

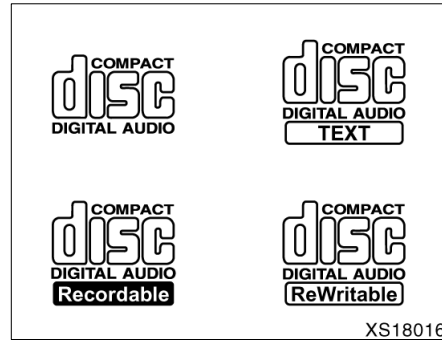

- Use only discs marked as shown above. The following products may not be playable on your changer.
SACD
Copy-protected CD
CD-ROM

⚠ CAUTION

CD changer and DVD changer use an invisible laser beam which could cause hazardous radiation exposure if directed outside the unit. Be sure to operate the changers correctly.

AUDIO/VIDEO SYSTEM

DVD changer

Audio CDs	 
DVD video discs	 
DVD audio discs	
Video CDs	 

- Use only discs marked as shown above. The following products may not be playable on your changer.

SACD
 Copy-protected CD
 CD-ROM
 DVD+R
 DVD+RW
 DVD-ROM
 DVD-RAM



► Special shaped discs

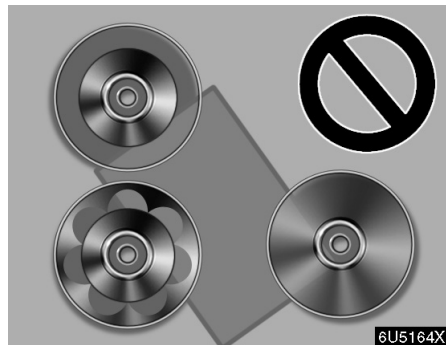

► Transparent/translucent discs

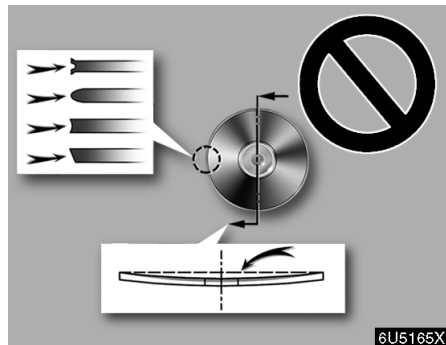

► Low quality discs

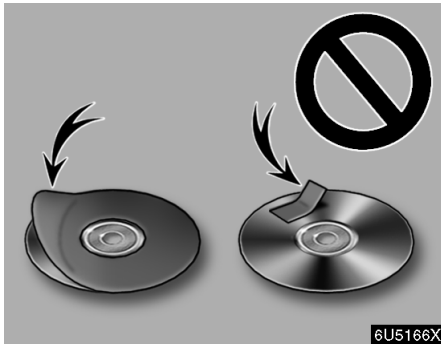

► Labeled discs

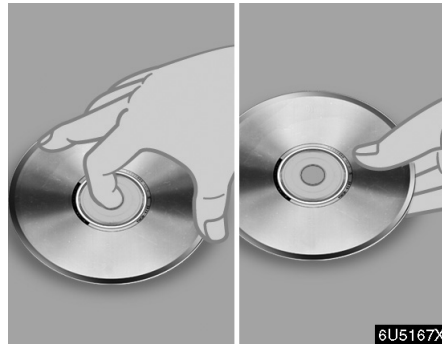

► Correct

► Wrong

NOTICE

- ***Do not use special shaped, transparent/translucent, low quality or labeled discs such as those shown in the illustrations. The use of such discs may damage the player or changer, or it may be impossible to eject the disc.***
- ***This system is not designed for use of Dual Disc. Do not use Dual Disc because it may cause damage to the changer.***
- ***Do not use a disc with protection ring. The use of such disc may damage the changer, or it may be impossible to eject the disc.***

- Handle discs carefully, especially when you are inserting them. Hold them on the edge and do not bend them. Avoid getting fingerprints on them, particularly on the shiny side.
- Dirt, scratches, warping, pin holes, or other disc damage could cause the player to skip or to repeat a section of a track. (To see a pin hole, hold the disc up to the light.)
- Remove discs from the players when you are not using them. Store them in their plastic cases away from moisture, heat, and direct sunlight.

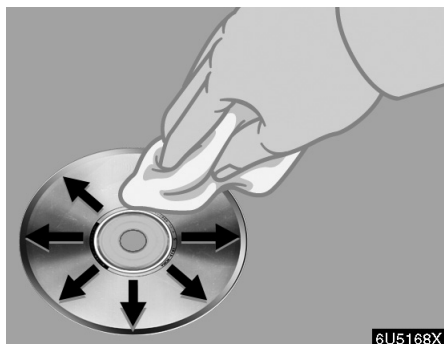

To clean a disc: Wipe it with a soft, lint-free cloth that has been dampened with water. Wipe in a straight line from the center to the edge of the disc (not in circles). Dry it with another soft, lint-free cloth. Do not use a conventional record cleaner or anti-static device.

MP3/WMA FILES

- MP3 (MPEG Audio Layer 3) and WMA (Windows Media® Audio) are audio compression standards.
- The MP3/WMA player can play MP3 and WMA files on CD-ROM, CD-R and CD-RW discs.

The unit can play disc recordings compatible with ISO 9660 level 1 and level 2 and with the Romeo and Joliet file system.

- When naming an MP3 or WMA file, add the appropriate file extension (.mp3 or .wma).
- The MP3/WMA player plays back files with .mp3 or .wma file extensions as MP3 or WMA files. To prevent noise and playback errors, use the appropriate file extensions.
- The MP3/WMA player can play only the first session using multi-session compatible CDs.
- MP3 player—MP3 files are compatible with the ID3 Tag Ver. 1.0, Ver. 1.1, Ver. 2.2, and Ver. 2.3 formats. The unit cannot display disc title, track title and artist name in other formats.
- USB memory—MP3 files are compatible with the ID3 Tag Ver. 1.0, Ver. 1.1, Ver. 2.2, Ver. 2.3 and Ver. 2.4 formats. The unit cannot display track title and artist name in other formats.
- WMA files can contain a WMA tag that is used in the same way as an ID3 tag. WMA tags carry information such as track title, artist name.
- The emphasis function is available only when playing MP3/WMA files recorded at 32, 44.1 and 48 kHz.

Sampling frequency

MP3 files for MP3 player:

MPEG 1 LAYER 3—32, 44.1, 48 kHz
MPEG 2 LSF LAYER 3—16, 22.05, 24 kHz

MP3 files for USB memory:

MPEG 1 AUDIO LAYER 2, 3—32, 44.1, 48 kHz

MPEG 2 AUDIO LAYER 2, 3—16, 22.05, 24 kHz

MPEG 2.5—8, 11.025, 12 kHz

WMA files for WMA player:

Ver. 7, 8, 9 CBR—32, 44.1, 48 kHz

WMA files for USB memory:

Ver. 9—HIGH PROFILE 32, 44.1, 48 kHz

- The sound quality of MP3/WMA files generally improves with higher bit rates. In order to achieve a reasonable level of sound quality, discs recorded with a bit rate of at least 128 kbps are recommended.

Playable bit rates

MP3 files for MP3 player:

MPEG1 LAYER3—64 to 320 kbps
MPEG2 LSF LAYER3—64 to 160 kbps

MP3 files for USB memory:

MPEG 1 AUDIO LAYER 2, 3—32 to 320 kbps

MPEG 2 AUDIO LAYER 2, 3—32 to 160 kbps

MPEG 2.5—32 to 160 kbps

WMA files for WMA player:

Ver. 7, 8 CBR—48 to 192 kbps

Ver. 9 CBR—48 to 320 kbps

WMA files for USB memory:

Ver. 9 CBR—32 to 320 kbps

- The MP3/WMA player does not play back MP3/WMA files from discs recorder using packet write data transfer (UDF format). Discs should be recorded using “pre-mastering” software rather than packet-write software.

- M3u playlists are not compatible with the audio player.
- MP3i (MP3 interactive) and MP3PRO formats are not compatible with the audio player.
- The player is compatible with VBR (Variable Bit Rate).
- When playing back files recorded as VBR (Variable Bit Rate) files, the play time will not be correctly displayed if fast-forward or reverse operations are used.
- It is not possible to check folders that do not include MP3/WMA files.
- MP3/WMA files in folders up to 8 levels deep can be played. However, the start of playback may be delayed when using discs containing numerous levels of folders. For this reason, we recommend creating discs with no more than two levels of folders.

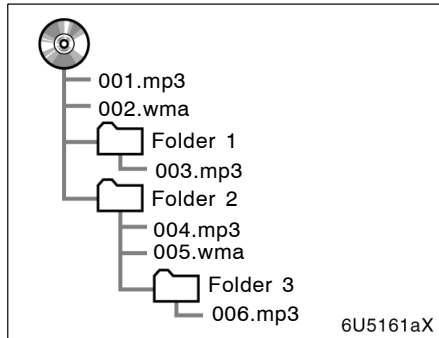

- The play order of the compact disc with the structure shown above is as follows:

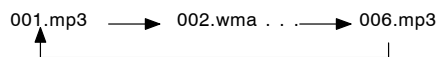

- MP3/WMA player—It is possible to play up to 192 folders or 255 files on one disc.
- USB memory—It is possible to play up to 999 folders, 255 files per folder or 65,025 files in device.
- The order changes depending on the PC and MP3/WMA encoding software you use.

CD-R and CD-RW discs

- CD-R/CD-RW discs that have not been subject to the “finalizing process” (a process that allows discs to be played on a conventional CD player) cannot be played.
- It may not be possible to play CD-R/CD-RW discs recorded on a music CD recorder or a personal computer because of disc characteristics, scratches or dirt on the disc, or dirt, condensation, etc. on the lens of the unit.
- It may not be possible to play discs recorded on a personal computer depending on the application settings and the environment. Record with the correct format. (For details, contact the appropriate application manufacturers of the applications.)
- CD-R/CD-RW discs may be damaged by direct exposure to sunlight, high temperatures or other storage conditions. The unit may be unable to play some damaged discs.
- If you insert a CD-RW disc into the MP3/WMA player, playback will begin more slowly than with a conventional CD or CD-R disc.
- Recordings on CD-R/CD-RW cannot be played using the DDCD (Double Density CD) system.

TERMS

Packet write—

This is a general term that describes the process of writing data on-demand to CD-R, etc., in the same way that data is written to floppy or hard discs.

ID3 Tag—

This is a method of embedding track-related information in an MP3 file. This embedded information can include the track title, the artist's name, the album title, the music genre, the year of production, comments and other data. The contents can be freely edited using software with ID3 tag editing functions. Although the tags are restricted to the number of characters, the information can be viewed when the track is played back.

WMA Tag—

WMA files can contain a WMA tag that is used in the same way as an ID3 tag. WMA tags carry information such as track title, artist name.

ISO 9660 format—

This is the international standard for the formatting of CD-ROM folders and files. For the ISO 9660 format, there are two levels of regulations.

Level 1:

The file name is in 8.3 format (8 character file names, with a 3 character file extension. File names must be composed of one-byte capital letters and numbers. The “_” symbol may also be included.)

Level 2:

The file name can have up to 31 characters (including the separation mark “.” and file extension). Each folder must contain fewer than 8 hierarchies.

m3u—

Playlists created using “WINAMP” software have a playlist file extension (.m3u).

MP3—

MP3 is an audio compression standard determined by a working group (MPEG) of the ISO (International Standard Organization). MP3 compresses audio data to about 1/10 the size of that on conventional discs.

WMA—

WMA (Windows Media® Audio) is an audio compression format developed by Microsoft®. It compresses files into a size smaller than that of MP3 files. The decoding formats for WMA files are Ver. 7, 8, and 9.

AUDIO/VIDEO SYSTEM
