

Correct driving posture

Drive in a good posture as follows:



- 1 Sit upright and well back in the seat. (→P. 46)
- 2 Adjust the position of the seat forward or backward to ensure the pedals can be reached and easily depressed to the extent required. (→P. 46)
- 3 Adjust the seatback so that the controls are easily operable.
- 4 Adjust the tilt and telescopic positions of the steering wheel downward so the air-bag is facing your chest. (→P. 62, 63)
- 5 Lock the head restraint in place with the center of the head restraint closest to the top of your ears. (→P. 54)
- 6 Wear the seat belt correctly. (→P. 56)

 **CAUTION****n While driving**

- I** Do not adjust the position of the driver's seat while driving.
Doing so could cause the driver to lose control of the vehicle.
- I** Do not place a cushion between the driver or passenger and the seatback.
A cushion may prevent correct posture from being achieved, and reduce the effectiveness of the seat belt and head restraint, increasing the risk of death or serious injury to the driver or passenger.
- I** Do not place anything under the front seats.
Objects placed under the front seats may become jammed in the seat tracks and stop the seat from locking in place. This may lead to an accident. The adjustment mechanism may also be damaged.

n Adjusting the seat position:

- I** Take care when adjusting the seat position to ensure that other passengers are not injured by the moving seat.
- I** Do not put your hands under the seat or near the moving parts to avoid injury.
Fingers or hands may become jammed in the seat mechanism.

1-7. Safety information

SRS airbags

The SRS airbags inflate when the vehicle is subjected to certain types of severe impacts that may cause significant injury to the occupants. They work together with the seat belts to help reduce the risk of death or serious injury.



► SRS front airbags

1 SRS driver airbag/front passenger airbag

Can help protect the head and chest of the driver and front passenger from impact with interior components.

2 Knee airbags

Can help provide driver and front passenger protection.

► SRS side and curtain shield airbags

3 SRS side airbags

Can help protect the torso of the front seat occupants.

4 SRS curtain shield airbags

Can help protect primarily the head of outside occupants.

Airbag system components

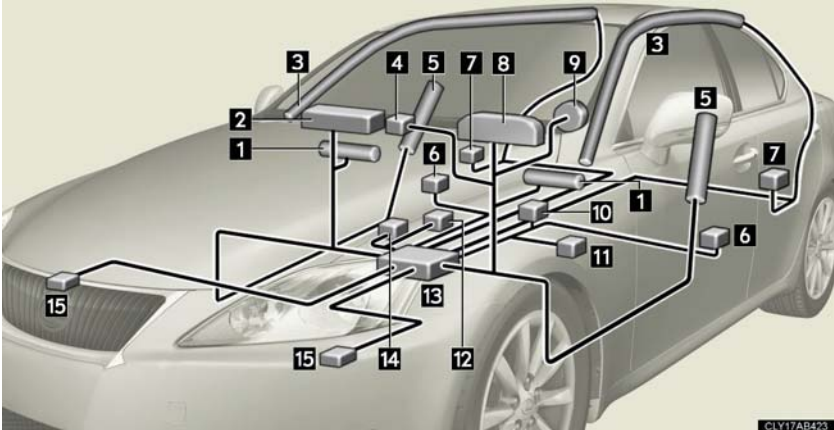

- | | |
|---|--|
| 1 Knee airbags | 8 SRS warning light |
| 2 Front passenger airbag | 9 Driver airbag |
| 3 Curtain shield airbags | 10 Driver's seat belt buckle switch |
| 4 "AIR BAG ON" and "AIR BAG OFF" indicator lights | 11 Driver's seat position sensor |
| 5 Side airbags | 12 Front passenger's seat belt buckle switch |
| 6 Side and curtain shield airbag sensors | 13 Airbag sensor assembly |
| 7 Curtain shield airbag sensors | 14 Occupant detection system (ECU and sensors) |
| | 15 Front airbag sensors |

Your vehicle is equipped with ADVANCED AIRBAGS designed based on US motor vehicle safety standards (FMVSS208). The airbag system controls airbag deployment power for the driver and front passenger. The driver airbag system consists of the driver seat's position sensor etc. The front passenger's airbag system consists of the front passenger occupant classification sensor etc.

The main SRS airbag system components are shown above. The SRS airbag system is controlled by the airbag sensor assembly. The airbag sensor assembly consists of a safing sensor and an airbag sensor.

In certain types of severe frontal or side impacts, the SRS airbag system triggers the airbag inflators. A chemical reaction in the inflators quickly fills the airbags with non-toxic gas to help restrain the motion of the occupants.

n SRS warning light

This warning light system monitors the airbag sensor assembly, front airbag sensors, side and curtain shield airbag sensor assemblies, curtain shield airbag sensor assemblies, driver's seat position sensor, driver's seat belt buckle switch, seat belt pretensioner assemblies, inflators, interconnecting wiring and power sources. (→P. 384)

n If the SRS airbags deploy (inflate)

- 1 Bruising and slight abrasions may result from contact with a deploying (inflating) SRS airbag.
- 1 A loud noise and white powder will be emitted.
- 1 Parts of the airbag module (steering wheel, airbag cover and inflator) as well as the front seats, and parts of the front pillar, rear pillar and roof side rail, may be hot for several minutes. The airbag itself may also be hot.
- 1 The windshield may crack.

n Operating conditions (front airbags)

- 1 The SRS front airbags will deploy if the severity of the frontal impact is above the designed threshold level, comparable to an approximate 15 mph (25 km/h) collision when the vehicle impacts straight into a fixed barrier that does not move or deform.

However, this threshold velocity will be considerably higher if the vehicle strikes an object, such as a parked vehicle or sign pole, which can move or deform on impact, or if the vehicle is involved in an underride collision (e.g. a collision in which the front of the vehicle “underrides”, or goes under, the bed of a truck, etc.).

- 1 It is possible that in some collisions where the forward deceleration of the vehicle is very close to the designed threshold level, the SRS front airbags and the seat belt pretensioners may not activate together.
- 1 The SRS front passenger airbag will not activate if there is no passenger sitting in the front passenger seat. However, the front passenger airbag may deploy if luggage is put in the seat, or the seat belt is fastened, even if the seat is unoccupied. (→P. 95)

n Operating conditions (side and curtain shield airbags)

- 1 The SRS side airbags and curtain shield airbags are designed to inflate when the passenger compartment is subjected to a severe impact from the side.
- 1 The SRS side airbag on the passenger seat will not activate if there is no passenger sitting in the front passenger seat. However, the side airbag on the passenger seat may deploy if luggage is put in the seat, even if the seat is unoccupied. (→P. 95)

n Conditions under which the SRS airbags may deploy (inflate), other than a collision

The SRS front airbags may also deploy if a serious impact occurs to the underside of your vehicle. Some examples are shown in the illustration.

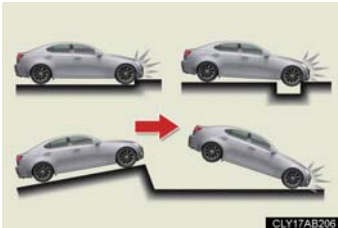

- 1 Hitting a curb, edge of pavement or hard surface
- 1 Falling into or jumping over a deep hole
- 1 Landing hard or vehicle falling

n Types of collisions that may not deploy the SRS airbag (front airbags)

The SRS front airbags are generally not designed to inflate if the vehicle is involved in a side or rear collision, if it rolls over, or if it is involved in a low-speed frontal collision. But, whenever a collision of any type causes sufficient forward deceleration of the vehicle, deployment of the SRS front airbags may occur.

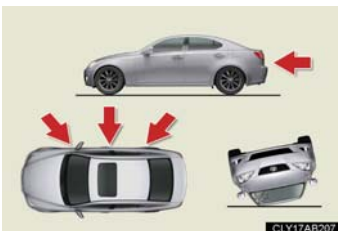

- 1 Collision from the side
- 1 Collision from the rear
- 1 Vehicle rollover

n Types of collisions that may not deploy the SRS airbag (side and curtain shield airbags)

The SRS side airbag and curtain shield airbag system may not activate if the vehicle is subjected to a collision from the side at certain angles, or a collision to the side of the vehicle body other than the passenger compartment.

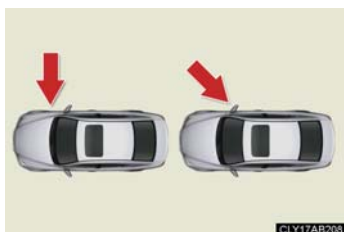

CLY17AB208

- 1 Collision from the side to the vehicle body other than the passenger compartment
- 1 Collision from the side at an angle

The SRS side airbags and curtain shield airbags are not generally designed to inflate if the vehicle is involved in a frontal or rear collision, if it rolls over, or if it is involved in a low-speed side collision.

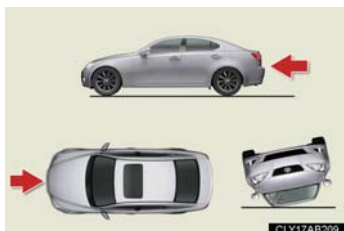

CLY17AB209

- 1 Collision from the front
- 1 Collision from the rear
- 1 Vehicle rollover

n When to contact your Lexus dealer

In the following cases, contact your Lexus dealer as soon as possible. Do not disconnect the battery cables before contacting your Lexus dealer.

1 Any of the SRS airbags have been inflated.

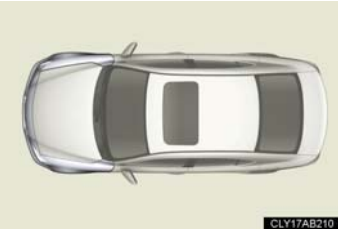

- 1 The front of the vehicle is damaged or deformed, or was involved in an accident that was not severe enough to cause the SRS airbags to inflate.



- 1 A portion of the doors is damaged or deformed, or the vehicle was involved in an accident that was not severe enough to cause the SRS side airbags and curtain shield airbags to inflate.



- 1 The pad section of the steering wheel, dashboard or lower portion of the instrument panel is scratched, cracked, or otherwise damaged.



- 1 The surface of the seats with the side airbag is scratched, cracked, or otherwise damaged.
- 1 The portion of the front pillars, rear pillars or roof side rail garnishes (padding) containing the curtain shield airbags inside is scratched, cracked, or otherwise damaged.

 CAUTION

n SRS airbag precautions

Observe the following precautions regarding the airbags.
Failure to do so may cause death or serious injury.

- 1** The driver and all passengers in the vehicle must wear their seat belts properly. The SRS airbags are supplemental devices to be used with the seat belts.
- 1** The SRS driver airbag deploys with considerable force, and can cause death or serious injury especially if the driver is very close to the airbag. The National Highway Traffic Safety Administration (“NHTSA”) advises:

Since the risk zone for driver airbag is the first 2 - 3 in. (50 - 75 mm) of inflation, placing yourself 10 in. (250 mm) from your driver airbag provides you with a clear margin of safety. This distance is measured from the center of the steering wheel to your breastbone. If you sit less than 10 in. (250 mm) away now, you can change your driving position in several ways:

- Move your seat to the rear as far as you can while still reaching the pedals comfortably.
- Slightly recline the back of the seat.
Although vehicle designs vary, many drivers can achieve the 10 in. (250 mm) distance, even with the driver seat all the way forward, simply by reclining the back of the seat somewhat. If reclining the back of your seat makes it hard to see the road, raise yourself by using a firm, non-slippery cushion, or raise the seat if your vehicle has that feature.
- If your steering wheel is adjustable, tilt it downward. This points the airbag toward your chest instead of your head and neck.

The seat should be adjusted as recommended by NHTSA above, while still maintaining control of the foot pedals, steering wheel, and your view of the instrument panel controls.

! CAUTION

n SRS airbag precautions



- I If the seat belt extender has been connected to the driver's seat belt buckle but the seat belt extender has not also been fastened to the latch plate of the driver's seat belt, the SRS driver's airbag system will judge that the driver is wearing the seat belt even though the seat belt has not been connected. In this case, the driver's airbag may not activate correctly in a collision, resulting in death or serious injury in the event of collision. Be sure to wear the seat belt with the seat belt extender.

- I The SRS front passenger airbag also deploys with considerable force, and can cause death or serious injury especially if the front passenger is very close to the airbag. The front passenger seat should be as far from the airbag as possible with the seatback adjusted, so the front passenger sits upright.

- I Improperly seated and/or restrained infants and children can be killed or seriously injured by a deploying airbag. An infant or child who is too small to use a seat belt should be properly secured using a child restraint system. Lexus strongly recommends that all infants and children be placed in the rear seats of the vehicle and properly restrained. The rear seats are the safest for infants and children. (→P.100)

! CAUTION

n SRS airbag precautions



1 Do not sit on the edge of the seat or lean against the dashboard.

1 Do not allow a child to stand in front of the SRS front passenger airbag unit or sit on the knees of a front passenger.

1 Do not drive the vehicle while the driver or passenger have items resting on their knees.

1 Do not lean against the door, the roof side rail or the front, side and rear pillars.

1 Do not allow anyone to kneel on the passenger seat toward the door or put their head or hands outside the vehicle.

⚠ CAUTION

n SRS airbag precautions

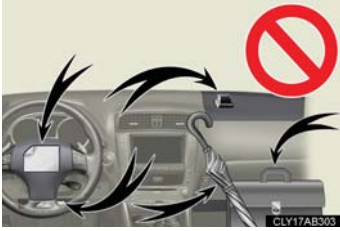

- 1 Do not attach anything to or lean anything against areas such as the dashboard, steering wheel pad and lower portion of the instrument panel.

These items can become projectiles when SRS driver, front passenger and knee airbags deploy.



- 1 Do not attach anything to areas such as the door, windshield glass, side door glass, front and rear pillars, roof side rail or assist grip.

- 1 Do not hang coat hangers or other hard objects on the coat hooks. All of these items could become projectiles and seriously injure or kill you, should the SRS curtain shield airbag deploy.

- 1 If the vinyl cover is put on the area where the SRS knee airbag will deploy, be sure to remove it.
- 1 Do not use seat accessories which cover the parts where the SRS side airbags inflate as they may interfere with inflation of the airbags.
- 1 Do not strike or apply significant levels of force to the area of the SRS airbag components shown on P. 85.
Doing so can cause the SRS airbags to malfunction.
- 1 Do not touch any of the component parts immediately after the SRS airbags have deployed (inflated) as they may be hot.
- 1 If breathing becomes difficult after the SRS airbag has deployed, open a door or window to allow fresh air in, or leave the vehicle if it is safe to do so. Wash off any residue as soon as possible to prevent skin irritation.
- 1 If the areas where the SRS airbags are stored, such as the steering wheel pad and front pillar garnish, are damaged or cracked, have them replaced by your Lexus dealer.

 **CAUTION**

n Modification and disposal of SRS airbag system components

Do not dispose of your vehicle or perform any of the following modifications without consulting your Lexus dealer.

The SRS airbag may malfunction or deploy (inflate) accidentally, causing death or serious injury.

- I** Installation, removal, disassembly and repair of the SRS airbags
- I** Repairs, modifications, removal or replacement of the steering wheel, instrument panel, dashboard, seats or seat upholstery, front, side and rear pillars or roof side rails
- I** Repairs or modifications of the front fender, front bumper, or side of the occupant compartment
- I** Installation of snow plows, winches, etc. to the front grille (bull bars, kangaroo bar etc.)
- I** Modifications to the vehicle's suspension system
- I** Installation of electronic devices such as mobile two-way radios or CD players
- I** Modifications to your vehicle for a person with a physical disability

Front passenger occupant classification system

Your vehicle is equipped with a front passenger occupant classification system. This system detects the conditions of the front passenger seat and activates or deactivates the devices for front passenger.



- 1 SRS warning light
- 2 "AIR BAG OFF" indicator light
- 3 "AIR BAG ON" indicator light
- 4 Front passenger's seat belt reminder light

Condition and operation in the front passenger occupant classification system

n Adult^{*1}

Indicator/ warning light	"AIR BAG ON" and "AIR BAG OFF" indicator lights	"AIR BAG ON"
	SRS warning light	Off
	Front passenger's seat belt reminder light	Flashing ^{*2}
Devices	Front passenger airbag	Activated
	Side airbag on the front passenger seat	
	Curtain shield airbag in the front passenger side	
	Front passenger knee airbag	
	Front passenger's seat belt pretensioner	

n Child^{*3} or child restraint system^{*4}

Indicator/ warning light	"AIR BAG ON" and "AIR BAG OFF" indicator lights	"AIR BAG OFF" ^{*5}
	SRS warning light	Off
	Front passenger's seat belt reminder light	Flashing ^{*2}
Devices	Front passenger airbag	Deactivated
	Side airbag on the front passenger seat	
	Curtain shield airbag in the front passenger side	Activated
	Front passenger knee airbag	Deactivated
	Front passenger's seat belt pretensioner	Activated

n Unoccupied

Indicator/ warning light	"AIR BAG ON" and "AIR BAG OFF" indicator lights	Not illuminated
	SRS warning light	Off
	Front passenger's seat belt reminder light	
Devices	Front passenger airbag	Deactivated
	Side airbag on the front passenger seat	
	Curtain shield airbag in the front passenger side	Activated
	Front passenger knee airbag	Deactivated
	Front passenger's seat belt pretensioner	

n There is a malfunction in the system

Indicator/ warning light	"AIR BAG ON" and "AIR BAG OFF" indicator lights	"AIR BAG OFF"
	SRS warning light	On
	Front passenger's seat belt reminder light	Off
Devices	Front passenger airbag	Deactivated
	Side airbag on the front passenger seat	
	Curtain shield airbag in the front passenger side	Activated
	Front passenger knee airbag	Deactivated
	Front passenger's seat belt pretensioner	Activated

- *1: The system judges a person of adult size as an adult. When a smaller adult sits in the front passenger seat, the system may recognize him/her as a child depending on his/her physique and posture.
- *2: In the event the front passenger does not wear a seat belt.
- *3: When a larger child who has outgrown a child restraint system sits in the front passenger seat, the system may recognize him/her as an adult depending on his/her physique or posture.

- *4: Never install a rear-facing child restraint system on the front passenger seat. A forward-facing child restraint system should only be installed on the front passenger seat when it is unavoidable. (→P. 100)
- *5: In case the indicator is not illuminated, consult this manual as for installing the child restraint system properly. (→P. 104)

CAUTION

n Front passenger occupant classification system precautions

Observe the following precautions regarding front passenger occupant classification system.

Failure to do so may cause death or serious injury.

- 1** Wear the seat belt properly.
- 1** Make sure the front passenger's seat belt tab has not been left inserted into the buckle before someone sits in the front passenger seat.
- 1** Make sure the "AIR BAG OFF" indicator light is not illuminated when using the seat belt extender for the front passenger seat. If the "AIR BAG OFF" indicator light is illuminated, disconnect the extender tongue from the seat belt buckle, then reconnect the seat belt. Reconnect the seat belt extender after making sure the "AIR BAG ON" indicator light is illuminated. If you use the seat belt extender while the "AIR BAG OFF" indicator light is illuminated, the front passenger airbag, side airbag on the front passenger side and front passenger knee airbag may not activate correctly, which could cause death or serious injury in the event of collision.
- 1** Do not put weight on the front passenger seat by putting your hands or feet on the front passenger seat seatback from the rear passenger seat.
- 1** Do not let a rear passenger lift the front passenger seat with their feet or press on the seatback with their legs.
- 1** Do not put objects under the front passenger seat.

 **CAUTION**
n Front passenger occupant classification system precautions

- 1 Do not recline the front passenger seatback so far that it touches a rear seat. This may cause the "AIR BAG OFF" indicator light to be illuminated, which indicates that the passenger's airbags will not deploy in the event of a severe accident. If the seatback touches the rear seat, return the seatback to a position where it does not touch the rear seat. Keep the front passenger seatback as upright as possible when the vehicle is moving. Reclining the seatback excessively may lessen the effectiveness of the seat belt system.
- 1 If an adult sits in the front passenger seat, the "AIR BAG ON" indicator light is illuminated. If the "AIR BAG OFF" indicator is illuminated, ask the passenger to sit up straight, well back in the seat, feet on the floor, and with the seat belt worn correctly. If the "AIR BAG OFF" indicator still remain illuminated, either ask the passenger to move to the rear seat, or if that is not possible, move the front passenger seat fully rearward.
- 1 When it is unavoidable to install the forward-facing child restraint system on the front passenger seat, install the child restraint system on the front passenger seat in the proper order. (→P. 104)
- 1 Do not modify or remove the front seats.
- 1 Do not kick the front passenger seat or subject it to severe impact. Otherwise, the SRS warning light may come on to indicate a malfunction of the detection system. In this case, contact your Lexus dealer immediately.
- 1 Child restraint systems installed on the rear seat should not contact the front seatbacks.
- 1 Do not use a seat accessory, such as a cushion or seat cover, that covers the seat cushion surface.
- 1 Do not modify or replace the upholstery of the front seat.

1-7. Safety information

Child restraint systems

A child restraint system for a small child or baby must itself be properly restrained on the seat with the lap portion of the lap/shoulder belt.

The laws of all 50 states of the U.S.A. and Canada now require the use of child restraint systems.

Points to remember

Studies have shown that installing a child restraint on a rear seat is much safer than installing one to the front passenger seat.

1 Choose a child restraint system that suits your vehicle and is appropriate to the age and size of the child.

1 For installation details, follow the instructions provided with the child restraint system.

General installation instructions are provided in this manual. (→P. 104)

Types of child restraints

Child restraint systems are classified into the following 3 types according to the age and size of the child.

► Rear facing — Infant seat/convertible seat



► Forward facing — Convertible seat



► Booster seat



n **Selecting an appropriate child restraint system**

- 1 Use a child restraint system appropriate for the child until the child becomes large enough to properly wear the vehicle's seat belt.
- 1 If a child is too large for a child restraint system, sit the child on a rear seat and use the vehicle's seat belt. (→P. 56)

! CAUTION

n **Child restraint precautions**

- 1 For effective protection in automobile accidents and sudden stops, a child must be properly restrained, using a seat belt or child restraint system depending on the age and size of the child. Holding a child in your arms is not a substitute for a child restraint system. In an accident, the child can be crushed against the windshield, or between you and the vehicle's interior.

 **CAUTION**

n Child restraint precautions

- I** Lexus strongly urges the use of a proper child restraint system that conforms to the size of the child, installed on the rear seat. According to accident statistics, the child is safer when properly restrained in the rear seat than in the front seat.
- I** Never install a rear-facing child restraint system on the front passenger seat even if the "AIR BAG OFF" indicator light is illuminated. In the event of an accident, the force of the rapid inflation of the front passenger airbag can cause death or serious injury to the child if the rear-facing child restraint system is installed on the front passenger seat.
- I** A forward-facing child restraint system may allowed to be installed on the front passenger seat only when it is unavoidable. A child restraint system that requires a top tether strap should not be used in the front passenger seat since there is no top tether strap anchor for the front passenger seat. Adjust the seatback as upright as possible and always move the seat as far back as possible even if the "AIR BAG OFF" indicator light is illuminated, because the front passenger airbag could inflate with considerable speed and force. Otherwise, the child may be killed or seriously injured.
- I** Do not use the seat belt extender when installing a child restraint system on the front or rear passenger seat. If installing a child restraint system with the seat belt extender connected to the seat belt, the seat belt will not securely hold the child restraint system, which could cause death or serious injury to the child or other passengers in the event of collision.
- I** Do not allow the child to lean his/her head or any part of his/her body against the door or the area of the seat, front pillar, rear pillar or roof side rail from which the side airbags or curtain shield airbags deploy even if the child is seated in the child restraint system. It is dangerous if the side airbags and curtain shield airbags inflate, and the impact could cause death or serious injury to the child.
- I** Make sure you have complied with all installation instructions provided by the child restraint manufacturer and that the system is properly secured. If it is not secured properly, it may cause death or serious injury to the child in the event of a sudden stop or accident.

 **CAUTION****n Child restraint lock function belt precaution**

Do not allow children to play with the child restraint lock function belt. If the belt becomes twisted around a child's neck, it will not be possible to pull the belt out leading to choking or other serious injuries that could result in death.

If this occurs and the buckle cannot be unfastened, scissors should be used to cut the belt.

n When the child restraint system is not in use

I Keep the child restraint system properly secured on the seat even if it is not in use. Do not store the restraint unsecured in the passenger compartment.

I If it is necessary to detach the child restraint system, remove it from the vehicle or store it securely in the trunk. This will prevent it from injuring passengers in the event of a sudden stop or accident.

1-7. Safety information

Installing child restraints

Follow the child restraint system manufacturer's instructions. Firmly secure child restraints to the rear seats using the LATCH anchors or a seat belt. Attach the top tether strap when installing a child restraint.

The lap/shoulder belt can be used if your child restraint system is not compatible with the LATCH (Lower Anchors and Tethers for Children) system.



Child restraint LATCH anchors

LATCH anchors are provided for the outside rear seats. (Buttons displaying the location of the anchors are attached to the seats.)



Seat belts equipped with a child restraint locking mechanism (ALR/ELR belts except driver's seat belt) (→P. 56)



Anchor bracket (for top tether strap)

Anchor brackets are provided for all rear seats.

Installation with LATCH system

► Type A

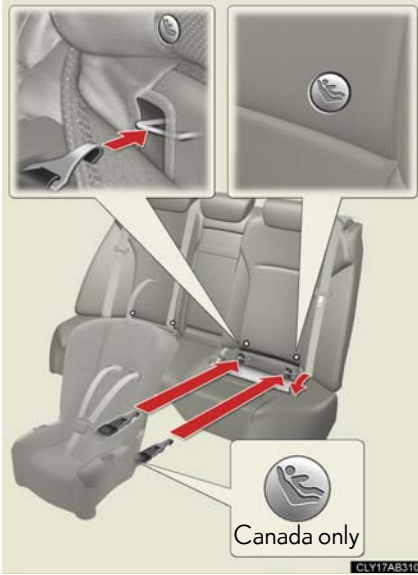

STEP 1 Flip the cover.

STEP 2 Latch the hooks of the lower straps onto the LATCH anchors.

STEP 3 If the child restraint has a top tether strap, the top tether strap should be latched onto the top tether strap anchors.

For owners in Canada:
The symbol on a child restraint system indicates the presence of a lower connector system.

1

Before driving

► Type B

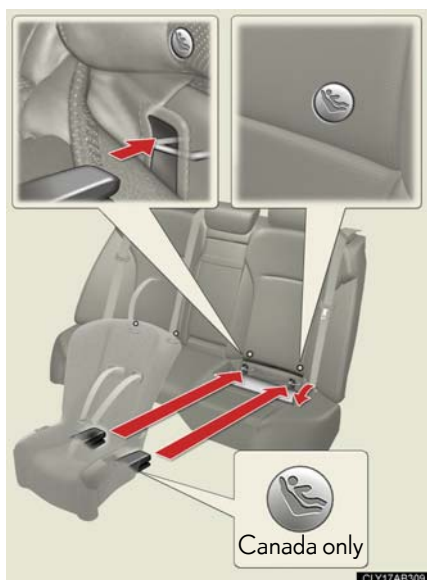

STEP 1 Flip the cover.

STEP 2 Latch the buckles onto the LATCH anchors.

STEP 3 If the child restraint has a top tether strap, the top tether strap should be latched onto the top tether strap anchors.

For owners in Canada:

The symbol on a child restraint system indicates the presence of a lower connector system.

Installing child restraints using a seat belt (child restraint lock function belt)

n Rear facing — Infant seat/convertible seat

STEP 1

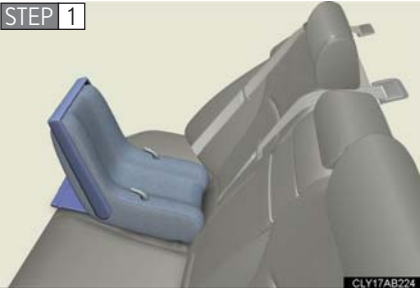

Place the child seat on the rear seat facing the rear of the vehicle.

STEP 2

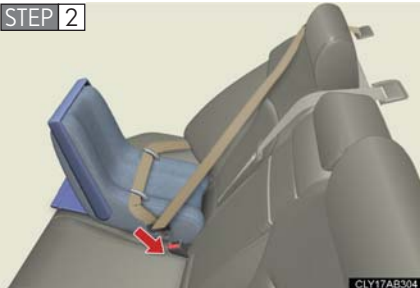

Run the seat belt through the child seat and insert the plate into the buckle. Make sure that the belt is not twisted.

STEP 3

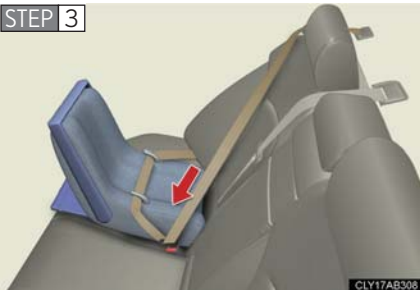

Fully extend the shoulder belt and then allow it to retract slightly in order to activate the ALR lock mode.

Lock mode allows the seat belt to retract only.

1

Before driving

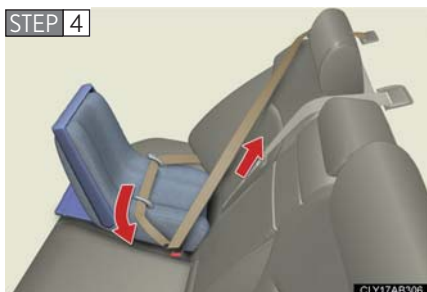

While pushing the child seat down into the rear seat, allow the shoulder belt to retract until the child seat is securely in place.

After the shoulder belt has retracted to a point where there is no slack in the belt, pull the belt to check that it cannot be extended.

n Forward facing — Convertible seat



Place the child seat on the seat facing the front of the vehicle.



Run the seat belt through the child seat and insert the plate into the buckle. Make sure that the belt is not twisted.



Fully extend the shoulder strap and then allow it to retract slightly into the ALR lock mode.

Lock mode allows the seat belt to retract only.



While pushing the child seat into the rear seat, allow the shoulder belt to retract until the child seat is securely in place.

After the shoulder belt has retracted to a point where there is no slack in the belt, pull the belt to check that it cannot be extended.

STEP 5 If the child restraint has a top tether strap, the top tether strap should be latched onto the top tether strap anchors.

n Booster seat



Place the booster seat on the seat facing the front of the vehicle.



Sit the child in the booster seat. Fit the seat belt to the booster seat according to the manufacturer's instructions and insert the plate into the buckle. Make sure that the belt is not twisted.

Check that the shoulder belt is correctly positioned over the child's shoulder, and that the lap belt is as low as possible. (→P. 56)

Removing a child restraint installed with a seat belt



Push the buckle release button and fully retract the seat belt.

Child restraint systems with a top tether strap



Secure the child restraint using a seat belt or a lower anchors, and lock the head restraint in place at the original position.



Open the anchor bracket cover, latch the hook onto the anchor bracket and tighten the top tether strap.

Make sure the top tether strap is securely latched.

n Laws and regulations pertaining to anchorages

The LATCH system conforms to FMVSS225 or CMVSS210.2.

Child restraint systems conforming to FMVSS213 or CMVSS213 specifications can be used.

This vehicle is designed to conform to the SAE J1819.

CAUTION

n When installing a booster seat

Do not fully extend the shoulder belt to prevent the belt from going to ALR lock mode: (→P. 58)

ALR mode causes the belt to tighten only which could cause injury or discomfort to the child.

! CAUTION

n When installing a child restraint system

Follow the directions given in the child restraint system installation manual and fix the child restraint system securely in place.

If the child restraint system is not correctly fixed in place, the child or other passengers may be injured or even killed in the event of sudden braking or an accident.



- 1 If the driver's seat interferes with the child restraint system and prevents it from being attached correctly, attach the child restraint system to the right-hand rear seat.



- 1 Only put a forward facing or booster child seat on the front seat when unavoidable. When installing a forward facing or booster child seat on the front passenger seat, move the seat as far back as possible even if the "AIR BAG OFF" indicator light is illuminated. Failing to do so may result in death or serious injury if the airbags deploy (inflate).

- 1 When a booster seat is installed, always ensure that the shoulder belt is positioned across the center of the child's shoulder. The belt should be kept away from the child's neck, but not so that it could fall off the child's shoulder. Failing to do so may result in death or serious injury in the event of an accident or sudden braking.
- 1 Make sure the outside rear seat head restraints are not in the folded position.
- 1 Ensure that the belt and tab are securely locked and the seat belt is not twisted.
- 1 Push and pull the child seat from side to side and forward to be sure it is secure.
- 1 After securing a child restraint system, never adjust the seat.
- 1 Follow all installation instructions provided by the child restraint system manufacturer

 **CAUTION****n Do not use a seat belt extender**

If a seat belt extender is used when installing a child restraint system, the seat belt will not securely hold the child restraint system, which could cause death or serious injury to the child or other passengers in the event of a collision.

n To correctly attach a child restraint system to the anchors

When using the LATCH anchors, be sure that there are no foreign objects around the anchors and that the seat belt is not caught behind the child restraint. Make sure the child restraint system is securely attached, or it may cause death or serious injury to the child or other passengers in the event of a sudden stop or accident.

